

FIBARO
ROLLER SHUTTER 3
FGR-223

CONTENTS

v1.0

#1: Description and features	3	#10: Power and energy consumption	17
#2: Installation	4	#11: Associations	18
#3: Adding the device	8	#12: Z-Wave range test	19
#4: Removing the device	9	#13: Activating scenes	20
#5: Positioning calibration	10	#14: Z-Wave specification	21
#6: Operating roller blinds	13	#15: Advanced parameters	24
#7: Operating gate motors	14	#16: Specifications	32
#8: Menu	15	#17: Regulations	33
#9: Resetting to factory defaults	16		

Important safety information



Read this manual before attempting to install the device!

Failure to observe recommendations included in this manual may be dangerous or cause a violation of the law. The manufacturer, Fibar Group S.A. will not be held responsible for any loss or damage resulting from not following the instructions of operating manual.



Danger of electrocution!

FIBARO Roller Shutter 3 is designed to operate in electrical home installation. Faulty connection or use may result in fire or electric shock.

All works on the device may be performed only by a qualified and licensed electrician. Observe national regulations.

Even when the device is turned off, voltage may be present at its terminals. Any maintenance introducing changes into the configuration of connections or the load must be always performed with disabled fuse.



Caution

It is not recommended to operate all of the roller blinds simultaneously. For safety reasons, at least one roller blind should be controlled independently, providing safe escape route in case of emergency.

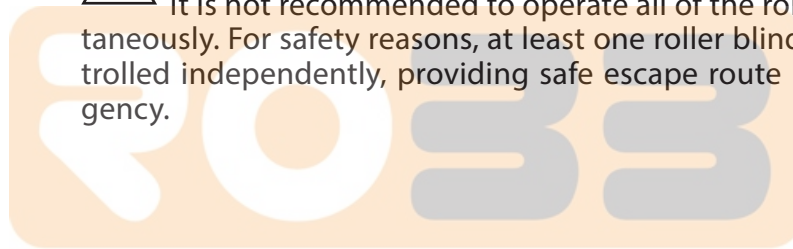

DÉ DOMOTICA SHOP

#1: Description and features

FIBARO Roller Shutter 3 is a device designed to control roller blinds, awnings, venetian blinds, gates and other single phase, AC powered devices.

Roller Shutter 3 allows precise positioning of roller blinds or venetian blind lamellas. The device is equipped with power and energy monitoring. It allows to control connected devices either via the Z-Wave network or via a switch connected directly to it.

Main features of FIBARO Roller Shutter 3:

- Compatible with any Z-Wave or Z-Wave+ Controller,
- Supports Z-Wave network Security Modes: S0 with AES-128 encryption and S2 Authenticated with PRNG-based encryption,
- To be installed with roller blind motors with electronic or mechanical limit switches,
- Advanced microprocessor control,
- Active power and energy metering functionality,
- Works with various types of switches – momentary, toggle and dedicated roller blind switches,
- To be installed in wall switch boxes.



FIBARO Roller Shutter 3 is a fully compatible Z-Wave PLUS device.

NOTE

This device may be used with all devices certified with the Z-Wave Plus certificate and should be compatible with such devices produced by other manufacturers. All non-battery operated devices within the network will act as repeaters to increase reliability of the network.

NOTE

The device is a Security Enabled Z-Wave Plus product and a Security Enabled Z-Wave Controller must be used in order to fully utilize the product.

#2: Installation



Connecting the Roller Shutter 3 in a manner inconsistent with this manual may cause risk to health, life or material damage.

- Connect only in accordance with one of the diagrams,
- Do not connect DC powered motors, the device is dedicated to operate AC powered electric motors,
- Do not connect the device to loads exceeding recommended values,
- The device should be installed in a wall switch box compliant with a relevant national safety standards and with depth no less than 60mm,
- Electrical switches used in installation should be compliant with the relevant safety standards,
- Length of wires used to connect the control switch should not exceed 20m,
- Connect roller blind motors with electronic or mechanical limit switches only.

Notes for the diagrams:

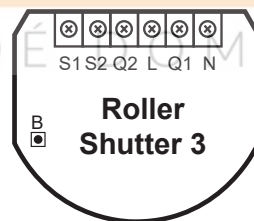

S1 - terminal for 1st switch (used to add/remove the device)

S2 - terminal for 2nd switch

Q2 - 2nd output terminal for shutter motor

Q1 - 1st output terminal for shutter motor

L - terminal for live lead

N - terminal for neutral lead

B - service button (used to add/remove the device and navigate the menu)

Tips for arranging the antenna:

- Locate the antenna as far from metal elements as possible (connecting wires, bracket rings, etc.) in order to prevent interferences,
- Metal surfaces in the direct vicinity of the antenna (e.g. flush mounted metal boxes, metal door frames) may impair signal reception!
- Do not cut or shorten the antenna - its length is perfectly matched to the band in which the system operates.
- Make sure no part of the antenna sticks out of the wall switch box.

Installation with standard blinds:

1. Switch off the mains voltage (disable the fuse).
2. Open the wall switch box.
3. Connect with the following the diagram:

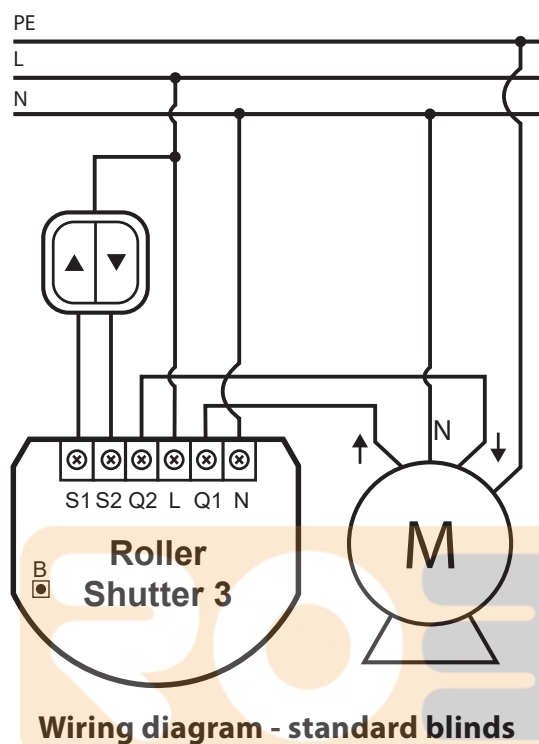

4. Verify if the device is connected correctly.
5. Arrange the device and its antenna in a wall switch box.
6. Close the wall switch box .
7. Switch on the mains voltage.

Installation with blinds with built-in driver:

1. Switch off the mains voltage (disable the fuse).
2. Open the wall switch box.
3. Connect with the following the diagram:

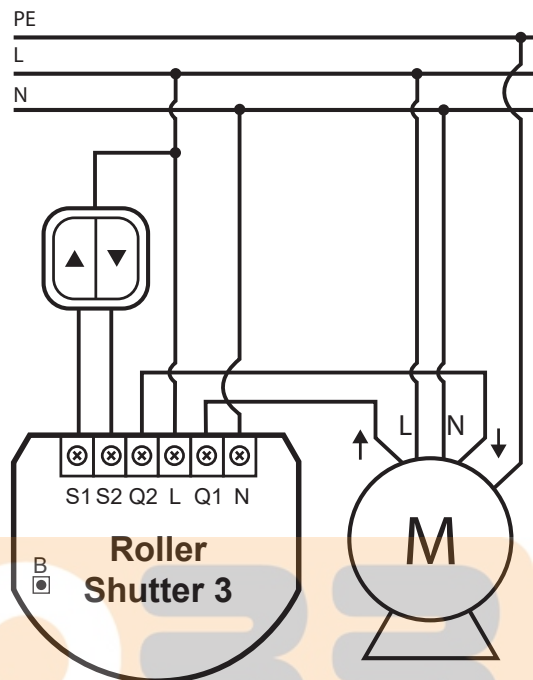

Wiring diagram - blinds with built-in driver

4. Verify if the device is connected correctly.
5. Arrange the device and its antenna in a wall switch box.
6. Close the wall switch box .
7. Switch on the mains voltage.

Installation with gate motors:

- Installation of the gate driver may be performed only by certified professionals.
- The motor must be equipped with the appropriate limit switches.
- It is recommended to connect a NC (normally closed) contact of an IR barrier to S2 terminal. Opening the contact will stop the gate.
- In addition, it is recommended to connect an emergency stop button to the motors neutral (N) wire. In emergency, pushing the emergency stop button will cut the power and stop the gate.

1. Switch off the mains voltage (disable the fuse).
2. Open the installation box.
3. Connect with the following the diagram:

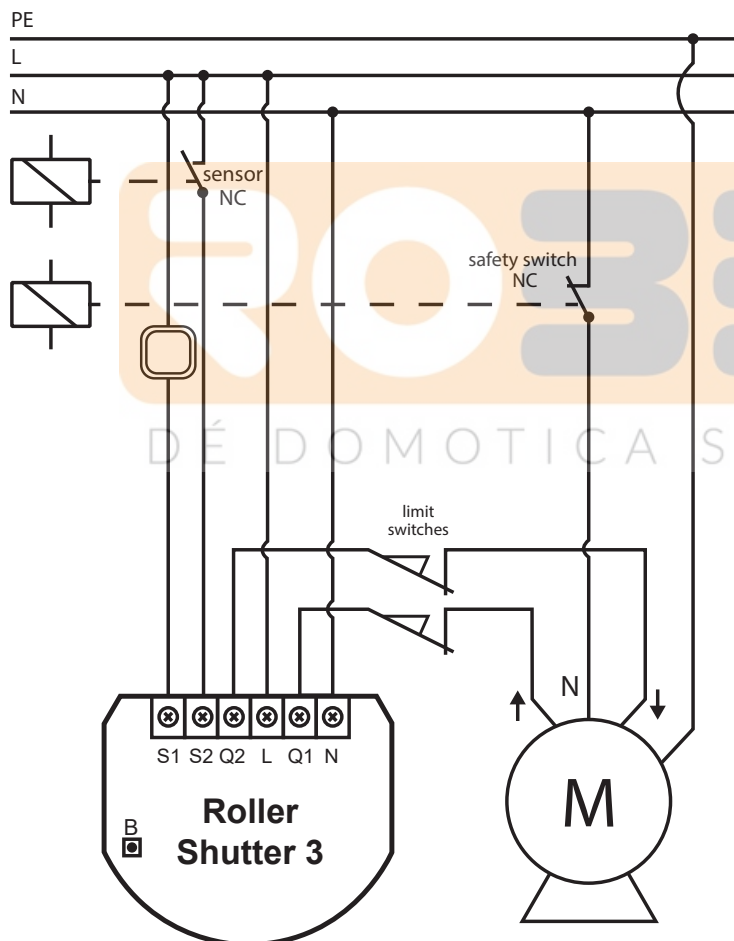

Wiring diagram - gate motors

4. Verify if the device is connected correctly.
5. Arrange the device and its antenna in the installation box.
6. Close the installation box.
7. Switch on the mains voltage.

#3: Adding the device

Adding (Inclusion) - Z-Wave device learning mode, allowing to add the device to existing Z-Wave network.

i NOTE

In case of problems with adding using the S1 switch, use B-button instead (located on the housing).

To add the device to the Z-Wave network **manually**:

1. Power the device.
2. Identify the S1 switch.
3. Set the main controller in (Security/non-Security Mode) add mode (see the controller's manual).
4. Quickly, triple click the S1 switch.
5. If you are adding in Security S2 Authenticated, scan the DSK QR code or input the 5-digit PIN code (label on the bottom of the box).
6. Wait for the adding process to end.
7. Successful adding will be confirmed by the Z-Wave controller's message.

i NOTE

SmartStart enabled products can be added to SmartStart enabled Z-Wave controller by scanning the Z-Wave QR Code present on the product. SmartStart product will be added automatically within 10 minutes of being switched on in the network range.

To add the device to the Z-Wave network **using Smart Start**:

1. Set the main controller in Security S2 Authenticated add mode (see the controller's manual).
2. Scan the DSK QR code or input the 5-digit PIN code (label on the bottom of the box)
3. Power the device (turn on the mains voltage).
4. LED will start blinking yellow, wait for the adding process to end.
5. Successful adding will be confirmed by the Z-Wave controller's message.

#4: Removing the device

Removing (Exclusion) - Z-Wave device learning mode, allowing to remove the device from existing Z-Wave network.

Removing the device restores all the default parameters of the device, but does not reset power metering data.

To remove the device from the Z-Wave network:

1. Make sure the device is powered.
2. Identify the S1 switch.
3. Set the main controller in remove mode (see the controller's manual).
4. Quickly, triple click the S1 switch.
5. Wait for the removing process to end.
6. Successful removing will be confirmed by the Z-Wave controller's message.



i NOTE

In case of problems with removing using the S1 switch, use B-button instead (located on the housing).

i NOTE

If parameter 40 enables scenes for triple S1 click, disable it or use B-button instead to remove the device.

i NOTE

If parameter 24 is set to 1, use S2 switch instead to remove the device.

#5: Positioning calibration

i NOTE

If you notice the calibration process fail (e.g. it does not start, movement times are really short or highly inaccurate), adjust parameter 155 value (e.g. reduce it by half).

Calibration is a process during which a device learns the position of the limit switches and a motor characteristic.

Calibration is mandatory in order for the device to correctly recognize a roller blind position.

The procedure consists of an automatic, full movement between the limit switches (up, down, and up again).

Description:

▲ – switch connected to the S1 terminal

▼ – switch connected to the S2 terminal

Standard roller blind positioning

Calibration using connected momentary switch

1. Make sure:
 - the device is supplied,
 - momentary switch is connected to S1 and S2 terminals,
 - the device added to the Z-Wave network,
 - parameter 151 is set to 1 or 2.
2. Press and hold ▲ or ▼ switch for at least 3 seconds
3. Press and hold the same switch again for at least 3 seconds.
4. Press and hold the same switch again for at least 3 seconds.
5. The device will perform the calibration process, completing full cycle – up, down and up again.
6. Test whether the positioning works correctly.

Calibration using the B-button

1. Make sure:
 - the device is supplied,
 - the device added to the Z-Wave network,
 - parameter 151 is set to 1 or 2.
2. Press and hold the B-button.
3. Wait for the LED to glow white.
4. Quickly release and click the B-button again.
5. The device will perform the calibration process, completing full cycle – up, down and up again
6. Test whether the positioning works correctly.

Calibration using parameter

1. Make sure:
 - the device is supplied,
 - the device added to the Z-Wave network,
 - parameter 151 is set to 1 or 2.
2. Set the parameter 150 value to 2
3. The device will perform the calibration process, completing full cycle – up, down and up again
4. The parameter 150 value will be set to 1 after calibration finishes.
5. Test whether the positioning works correctly.

Slats positioning in venetian blinds mode

Calibration using connected momentary switch

1. Make sure:
 - the device is supplied,
 - momentary switch is connected to S1 and S2 terminals,
 - the device added to the Z-Wave network,
 - parameter 151 is set to 2,
 - blinds are calibrated.
2. By default, time of transition between extreme positions is set to 150 (1.5 seconds) in parameter 152.
3. Turn slats between extreme positions by holding ▲ or ▼ switch:
 - If after full cycle a blind starts moving up or down - decrease value of parameter 152,
 - If after full cycle the slats does not reach end positions - increase value of parameter 152,
4. Repeat previous step until satisfactory positioning is achieved.
5. Test whether the positioning works correctly. Correctly configured slats should not force the blinds to move up or down.

Roller blind with built-in driver positioning

1. Make sure:
 - the device is supplied,
 - momentary switch is connected to S1 and S2 terminals,
 - the device added to the Z-Wave network,
 - parameter 151 is set to 5 or 6.
2. By default, time of transition between extreme positions is set to 600 (6 seconds) in parameters 155 and 156.
3. Move roller blinds between extreme positions by clicking ▲ or ▼ switch:
 - If roller blind stops before reaching top - increase value of parameter 155,
 - If roller blind does not stop after reaching top - decrease value of parameter 155,
 - If roller blind stops before reaching bottom - increase value of parameter 156,
 - If roller blind does not stop after reaching bottom - decrease value of parameter 156,
4. Repeat previous step until satisfactory positioning is achieved.
5. Test whether the positioning works correctly.

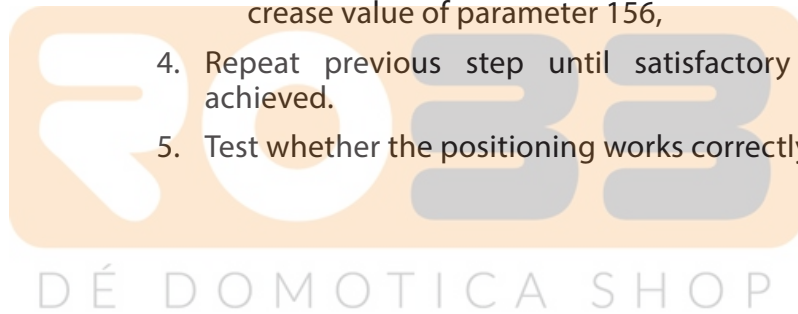

#6: Operating roller blinds

The device allows for connecting switch to the S1 and S2 terminals. These may be momentary (recommended) or toggle switches.

Switch buttons are responsible for managing the blind's movement.

Description:

▲ – switch connected to the S1 terminal

▼ – switch connected to the S2 terminal

Using momentary switches:

Click ▲ switch – initiate up movement.

Click ▼ switch – initiate down movement.

If the blind is moving, clicking any button, will stop the movement.

Operating slats of venetian blinds

When operating venetian blinds it is possible to manage angle of the slats.

Hold ▲ switch – initiate slats rotation up.

Hold ▼ switch – initiate slats rotation down.

Using toggle switches:

Change ▲ switch state – initiate up movement.

Change ▼ switch state – initiate down movement.

Choosing a middle position stops the blinds.

NOTE

Momentary switch

After releasing the switch a spring automatically pushes back and disconnects the switch)

Toggle switch

Operates as a two-position switch, it has no spring that would set one position of the switch.

#7: Operating gate motors

i NOTE

Momentary switch

After releasing the switch a spring automatically pushes back and disconnects the switch)

The device allows to operate gate motors.

Gate motor should be connected to Q1 and Q2 terminals according to installation diagram.

When operating gates a momentary switch may be connected to S1 terminal.

It is recommended to connect an IR barrier, an emergency stop button or any alarm mechanism to S2 terminal. Opening a contact in a device connected to S2 terminal will always result in stopping a motor in current position.

Using momentary switch:

Click S1 switch – move gate in sequence:

OPEN -> STOP -> CLOSE -> STOP -> OPEN

Open S2 contact – stop movement

Automatic closing:

- After full opening – the gate will automatically start closing after time specified in parameter 152,
- After opening S2 contacts – the gate will automatically start closing after time specified in parameter 154.

#8: Menu

Menu allows to perform Z-Wave network actions. In order to use the menu:

1. Switch off the mains voltage (disable the fuse).
2. Remove the device from the wall switch box.
3. Switch on the mains voltage.
4. Press and hold the B-button to enter the menu.
5. Wait for the LED to indicate the desired menu position with colour:
 - **WHITE** - start calibration
 - **GREEN** - reset energy consumption memory
 - **VIOLET** - start range test
 - **YELLOW** - reset the device
6. Quickly release and click the B-button again.



#9: Resetting to factory defaults

i NOTE

Resetting the device is not the recommended way of removing the device from the Z-Wave network. Use reset procedure only if the primary controller is missing or inoperable. Certain device removal can be achieved by the procedure of removing described in "Adding the device" on page 5.

Resetting the device to factory defaults:

Reset procedure allows to restore the device back to its factory settings, which means all information about the Z-Wave controller and user configuration will be deleted.

1. Switch off the mains voltage (disable the fuse).
2. Remove the device from the wall switch box.
3. Switch on the mains voltage.
4. Press and hold the B-button to enter the menu.
5. Wait for the LED indicator to glow yellow.
6. Quickly release and click the B-button again.
7. After few seconds the device will be restarted, which is signalled with the red LED indicator colour.



#10: Power and energy consumption

The device allows for the active power and energy consumption monitoring. Data is sent to the main Z-Wave controller.

Measuring is carried out by the most advanced micro-controller technology, assuring maximum accuracy and precision (+/- 1% for loads 10W-1000W).

Electric active power - power that energy receiver is changing into a work and heat. The unit of active power is Watt [W].

Electric energy - energy consumed by a device through a time period. Consumers of electricity in households are billed by suppliers on the basis of active power used in given unit of time. Most commonly measured in kilowatt-hour [kWh]. One kilowatt-hour is equal to one kilowatt of power consumed over period of one hour, 1kWh = 1000Wh.

Resetting consumption memory:

The device allows to erase stored consumption data in three ways:

- a) Using functionality of a Z-Wave controller (see the controller's manual).
- b) Manually clearing the data using the following procedure:
 1. Switch off the mains voltage (disable the fuse).
 2. Remove the device from the wall switch box.
 3. Switch on the mains voltage.
 4. Press and hold the B-button to enter the menu.
 5. Wait for the visual LED indicator to glow green.
 6. Quickly release and click the B-button again.
 7. Energy consumption memory will be erased.
- c) By resetting the device (see "Operating the device" on page 13).

NOTE

Power measurement can contain mains voltage fluctuations within +/- 10%.

CAUTION

The device stores periodically (every hour) the consumption data in the device memory. Disconnecting the module from the power supply will not erase stored energy consumption data.

#11: Associations

Association (linking devices) - direct control of other devices within the Z-Wave system network e.g. Dimmer, Relay Switch, Roller Shutter or scene (may be controlled only through a Z-Wave controller).

The device provides the association of 3 groups:

1st association group – “Lifeline” reports the device status and allows for assigning single device only (main controller by default).

2nd association group – “Roller Shutter” is assigned to shutter position control – UP/DOWN (uses Switch Multilevel command class).

3rd association group – “Slats” is assigned to slats position control – UP/DOWN (uses Switch Multilevel command class).

The device in 2nd and 3rd group allows to control 5 regular or multichannel devices per an association group, with the exception of “LifeLine” that is reserved solely for the controller and hence only 1 node can be assigned.

To add an association (using the Home Center controller):

1. Go to the device options by clicking the icon: 
2. Select the „Advanced” tab.
3. Click the “Setting Association” button.
4. Specify to which group and what devices are to be associated.
5. Save the changes.
6. Wait for the configuration process to end.

Association groups mapping:

Root	Endpoint	Association Group in Endpoint
Association Group 2	Endpoint 1	Association Group 2
Association Group 3	Endpoint 2	Association Group 2

#12: Z-Wave range test

The device has a built in Z-Wave network main controller's **range tester**.

Follow the below instructions to test the main controller's range:

1. Switch off the mains voltage (disable the fuse).
2. Remove the device from the wall switch box.
3. Switch on the mains voltage.
4. Press and hold the B-button to enter the menu.
5. Wait for the visual LED indicator to glow violet.
6. Quickly release and click the B-button again.
7. Visual indicator will indicate the Z-Wave network's range (range signalling modes described below).
8. To exit Z-Wave range test, click the B-button.

Z-Wave range tester signalling modes:

Visual indicator pulsing green - the device attempts to establish a direct communication with the main controller. If a direct communication attempt fails, the device will try to establish a routed communication, through other modules, which will be signalled by visual indicator pulsing yellow.

Visual indicator glowing green - the device communicates with the main controller directly.

Visual indicator pulsing yellow - the device tries to establish a routed communication with the main controller through other modules (repeaters).

Visual indicator glowing yellow - the device communicates with the main controller through the other modules. After 2 seconds the device will retry to establish a direct communication with the main controller, which will be signalled with visual indicator pulsing green.

Visual indicator pulsing violet - the device does communicate at the maximum distance of the Z-Wave network. If connection proves successful it will be confirmed with a yellow glow. It's not recommended to use the device at the range limit.

Visual indicator glowing red - the device is not able to connect to the main controller directly or through another Z-Wave network device (repeater).

CAUTION

To make Z-Wave range test possible, the device must be added to the Z-Wave controller. Testing may stress the network, so it is recommended to perform the test only in special cases.

NOTE

Communication mode of the device may switch between direct and one using routing, especially if the device is on the limit of the direct range.

#13: Activating scenes

The device can activate scenes in the Z-Wave controller by sending scene ID and attribute of a specific action using Central Scene Command Class.

By default scenes are not activated, set parameters 40 and 41 to enable scene activation for selected actions.

Switch	Action	Scene ID	Attribute
Switch connected to S1 terminal	Switch clicked once	1	Key Pressed 1 time
	Switch clicked twice	1	Key Pressed 2 times
	Switch clicked thrice	1	Key Pressed 3 times
	Switch held*	1	Key Held Down
	Switch released*	1	Key Released
Switch connected to S2 terminal	Switch clicked once	2	Key Pressed 1 time
	Switch clicked twice	2	Key Pressed 2 times
	Switch clicked thrice	2	Key Pressed 3 times
	Switch held*	2	Key Held Down
	Switch released*	2	Key Released

* Not available for toggle switches.

#14: Z-Wave specification

Endpoint 1:

Generic Device Class: GENERIC_TYPE_SWITCH_MULTILEVEL

Specific Device Class: SPECIFIC_TYPE_CLASS_B_MOTOR_CONTROL

Description: represents switch connected to the S1 terminal.

Endpoint 2:

Generic Device Class: GENERIC_TYPE_SWITCH_MULTILEVEL

Specific Device Class: SPECIFIC_TYPE_CLASS_B_MOTOR_CONTROL

Description: represents switch connected to the S2 terminal.

Switch Multilevel Command Class values refers to:

- 0x00 - fully close
- 0x63 - fully open

Supported Command Classes:

Command Class	Version	Secure
ZWAVEPLUS_INFO [0x5E]	V2	
SWITCH_MULTILEVEL [0x26]	V4	YES
ASSOCIATION [0x85]	V2	YES
MULTI_CHANNEL_ASSOCIATION [0x8E]	V3	YES
ASSOCIATION_GRP_INFO [0x59]	V2	YES
TRANSPORT_SERVICE [0x55]	V2	
VERSION [0x86]	V2	YES
MANUFACTURER_SPECIFIC [0x72]	V2	YES
DEVICE_RESET_LOCALLY [0x5A]	V1	YES
POWERLEVEL [0x73]	V1	YES
SECURITY [0x98]	V1	
SECURITY_2 [0x9F]	V1	
SUPERVISION [0x6C]	V1	
METER [0x32]	V3	YES
CONFIGURATION [0x70]	V1	YES
CRC_16_ENCAP [0x56]	V1	
NOTIFICATION [0x71]	V8	YES
PROTECTION [0x75]	V2	YES
MULTI_CHANNEL [0x60]	V4	YES
CENTRAL_SCENE [0x5B]	V3	YES
FIRMWARE_UPDATE_MD [0x7A]	V4	YES
APPLICATION_STATUS [0x22]	V1	
BASIC [0x20]	V1	YES

Multichannel Command Class:

Command Class	Version	Secure
Endpoint 1		
ZWAVEPLUS_INFO [0x5E]	V2	
SWITCH_MULTILEVEL [0x26]	V4	YES
ASSOCIATION [0x85]	V2	YES
MULTI_CHANNEL_ASSOCIATION [0x8E]	V3	YES
ASSOCIATION_GRP_INFO [0x59]	V2	YES
SECURITY [0x98]	V1	
SECURITY_2 [0x9F]	V1	
SUPERVISION [0x6C]	V1	
METER [0x32]	V3	YES
NOTIFICATION [0x71]	V8	YES
APPLICATION_STATUS [0x22]	V1	
Endpoint 2		
ZWAVEPLUS_INFO [0x5E]	V2	
SWITCH_MULTILEVEL [0x26]	V4	YES
ASSOCIATION [0x85]	V2	YES
MULTI_CHANNEL_ASSOCIATION [0x8E]	V3	YES
ASSOCIATION_GRP_INFO [0x59]	V2	YES
SECURITY [0x98]	V1	
SECURITY_2 [0x9F]	V1	
SUPERVISION [0x6C]	V1	
APPLICATION_STATUS [0x22]	V1	

Notification Command Class:

The device uses Notification Command Class to report different events to the controller (“Lifeline” group).

Notification Type	Event	Event Parameters
Power Management [0x08]	Over-current detected [0x06]	
System [0x09]	System Hardware Failure [0x03]	Device overheat [0x01]

Protection CC:

Protection Command Class allows to prevent local or remote control of the device.

Type of protection	State	Description
Local	0	Unprotected - The device is not protected, and may be operated normally via S1 or S2
Local	2	No operation possible – S1 and S2 cannot change relay state, any other functionality is available (menu)
RF (remote)	0	Unprotected - The device accepts and respond to all RF Commands
RF (remote)	1	No RF control – command class Basic and Switch Binary are rejected, every other command class will be handled

Meter Command Class:

Same for Root, Endpoint 1 and Endpoint 2.

Meter Type	Scale	Rate Type	Precision	Size
Electric [0x01]	Electric_kWh [0x00]	Import [0x01]	2	4
Electric [0x01]	Electric_W [0x02]	Import [0x01]	1	2

#15: Advanced parameters

FIBARO Roller Shutter 3 allows to customize its operation to user's needs. The settings are available in the FIBARO interface as simple options that may be chosen by selecting the appropriate box.

In order to configure the module (using the Home Center controller):

1. Go to the device options by clicking the icon: 
2. Select the „Advanced” tab.

INPUT/OUTPUT CONFIGURATION

20. Switch type

This parameter defines as what type the device should treat the switch connected to the S1 and S2 terminals.

This parameter is not relevant in gate operating modes (parameter 151 set to 3 or 4). In this case switch always works as a momentary and has to be connected to S1 terminal.

Available settings:	0 – momentary switches 1 – toggle switches 2 – single, momentary switch (the switch should be connected to S1 terminal)		
Default setting:	2	Parameter size:	1 [byte]

24. Inputs orientation

This parameter allows reversing the operation of switches connected to S1 and S2 without changing the wiring.

Available settings:	0 - default (S1 - 1st channel, S2 - 2nd channel) 1 - reversed (S1 - 2nd channel, S2 - 1st channel)		
Default setting:	0	Parameter size:	1 [byte]

25. Outputs orientation

This parameter allows reversing the operation of Q1 and Q2 without changing the wiring (in case of invalid motor connection) to ensure proper operation.

Available settings:	0 - default (Q1 - 1st channel, Q2 - 2nd channel) 1 - reversed (Q1 - 2nd channel, Q2 - 1st channel)		
Default setting:	0	Parameter size:	1 [byte]

i NOTE

If parameter 20 is set to 1 (toggle switch), change value of parameter 153 to 0 for slats to work properly.

ALARM CONFIGURATION

30. Alarm configuration - 1st slot

This parameter determines to which alarm frames and how the device should react. The parameters consist of 4 bytes, three most significant bytes are set according to the official Z-Wave protocol specification.

Available settings:	1B [MSB] - Notification Type 2B - Notification Status 3B - Event/State Parameters 4B [LSB] - action: 0 - no action 1 - open blinds 2 - close blinds
Default setting:	[0x00, 0x00, 0x00, 0x00] (disabled)
Parameter size:	4 [bytes]

31. Alarm configuration - 2nd slot (Water)

This parameter determines to which alarm frames and how the device should react. The parameters consist of 4 bytes, three most significant bytes are set according to the official Z-Wave protocol specification.

Available settings:	1B [MSB] - Notification Type 2B - Notification Status 3B - Event/State Parameters 4B [LSB] - action: 0 - no action 1 - open blinds 2 - close blinds
Default setting:	[0x05, 0xFF, 0x00, 0x00] (Water Alarm, any notification, no action)
Parameter size:	4 [bytes]

i NOTE

Alarm with lower number has the higher priority, thus first alarm will override other alarms with the same type.

i NOTE

Setting Notification Value to 0xFF will result in launching the action twice: when alarm occurs and is cancelled.

32. Alarm configuration - 3rd slot (Smoke)

This parameter determines to which alarm frames and how the device should react. The parameters consist of 4 bytes, three most significant bytes are set according to the official Z-Wave protocol specification.

Available settings:	1B [MSB] - Notification Type 2B - Notification Status 3B - Event/State Parameters 4B [LSB] - action: 0 - no action 1 - open blinds 2 - close blinds
Default setting:	[0x01, 0xFF, 0x00, 0x00] (Smoke Alarm, any notification, no action)
Parameter size:	4 [bytes]

33. Alarm configuration - 4th slot (CO)

This parameter determines to which alarm frames and how the device should react. The parameters consist of 4 bytes, three most significant bytes are set according to the official Z-Wave protocol specification.

Available settings:	1B [MSB] - Notification Type 2B - Notification Status 3B - Event/State Parameters 4B [LSB] - action: 0 - no action 1 - open blinds 2 - close blinds
Default setting:	[0x02, 0xFF, 0x00, 0x00] (CO Alarm, any notification, no action)
Parameter size:	4 [bytes]

34. Alarm configuration - 5th slot (Heat)

This parameter determines to which alarm frames and how the device should react. The parameters consist of 4 bytes, three most significant bytes are set according to the official Z-Wave protocol specification.

Available settings:	1B [MSB] - Notification Type 2B - Notification Status 3B - Event/State Parameters 4B [LSB] - action: 0 - no action 1 - open blinds 2 - close blinds
Default setting:	[0x04, 0xFF, 0x00, 0x00] (Heat Alarm, any notification, no action)
Parameter size:	4 [bytes]

SCENE TIGGERING CONFIGURATION

40. S1 switch - scenes sent

This parameter determines which actions result in sending scene IDs assigned to them.

Available settings:	1 - Key pressed 1 time 2 - Key pressed 2 times 4 - Key pressed 3 times 8 - Key hold down and key released	Parameter size:	1 [byte]
Default setting:	0		

41. S2 switch - scenes sent

This parameter determines which actions result in sending scene IDs assigned to them.

Available settings:	1 - Key pressed 1 time 2 - Key pressed 2 times 4 - Key pressed 3 times 8 - Key hold down and key released	Parameter size:	1 [byte]
Default setting:	0		

i NOTE

Parameter 40 values may be combined, e.g. 1+2=3 means that scenes for single and double click are sent.

i NOTE

Enabling triple click for S1 in parameter 40 disables the ability to add/remove via S1.

i NOTE

Parameter 41 values may be combined, e.g. 1+2=3 means that scenes for single and double click are sent.

POWER AND ENERGY REPORTING CONFIGURATION

60. Measuring power consumed by the device itself

This parameter determines whether the power metering should include the amount of active power consumed by the device itself.

Available settings:	0 - function inactive 1 - function active		
Default setting:	0	Parameter size:	1 [byte]

61. Power reports - on change

This parameter determines the minimum change in consumed power that will result in sending new power report to the main controller.

For loads under 50W, the parameter is not relevant and reports are sent every 5W change.

Power report are sent no often then every 30 seconds.

Available settings:	0 - reports are disabled 1-500 (1-500%) - change in power		
Default setting:	15 (15%)	Parameter size:	2 [bytes]

62. Power reports - periodic

This parameter determines in what time intervals the periodic power reports are sent to the main controller. Periodic reports do not depend on power change (parameter 61).

Available settings:	0 - periodic reports are disabled 30-32400 (30-32400s) - report interval		
Default setting:	3600 (1h)	Parameter size:	2 [bytes]

65. Energy reports - on change

This parameter determines the minimum change in consumed energy that will result in sending new energy report to the main controller.

Available settings:	0 - reports are disabled 1-500 (0.01 - 5 kWh) - change in energy		
Default setting:	10 (0.1 kWh)	Parameter size:	2 [bytes]

66. Energy reports - periodic

This parameter determines in what time intervals the periodic energy reports are sent to the main controller. Periodic reports do not depend on energy change (parameter 65).

Available settings:	0 - periodic reports are disabled 30-32400 (30-32400s) - report interval		
Default setting:	3600 (1h)	Parameter size:	2 [bytes]

ROLLER SHUTTER OPERATION CONFIGURATION

150. Force calibration

By setting this parameter to 2 the device enters the calibration mode. The parameter relevant only if the device is set to work in positioning mode (parameter 151 set to 1, 2 or 4).

Available settings:	0 - device is not calibrated 1 - device is calibrated 2 - force device calibration		
Default setting:	0	Parameter size:	1 [byte]

151. Operating mode

This parameter allows adjusting operation according to the connected device.

Available settings:	1 – roller blind (with positioning) 2 – Venetian blind (with positioning) 3 – gate (without positioning) 4 – gate (with positioning) 5 – roller blind with built-in driver 6 – roller blind with built-in driver (impulse)		
Default setting:	1	Parameter size:	1 [byte]

152. Venetian blind - time of full turn of the slats

For Venetian blinds (parameter 151 set to 2) the parameter determines time of full turn cycle of the slats.

For gates (parameter 151 set to 3 or 4) the parameter determines time after which open gate will start closing automatically (if set to 0, gate will not close).

The parameter is irrelevant for other modes.

Available settings:	0-90000 (0 - 900s, every 0.01s) - time of turn		
Default setting:	150 (1.5s)	Parameter size:	4 [bytes]

i NOTE

If parameter 20 is set to 1 (toggle switch), change value of parameter 153 to 0 for slats to work properly.

153. Set slats back to previous position

For Venetian blinds (parameter 151 set to 2) the parameter determines slats positioning in various situations.

The parameter is irrelevant for other modes.

Available settings:	0 – slats return to previously set position only in case of the main controller operation.		
	1 – slats return to previously set position in case of the main controller operation, momentary switch operation, or when the limit switch is reached.		
	2 – slats return to previously set position in case of the main controller operation, momentary switch operation, when the limit switch is reached or after receiving the Switch Multilevel Stop control frame		
Default setting:	1	Parameter size:	1 [byte]

154. Delay motor stop after reaching end switch

For blinds (parameter 151 set to 1, 2, 5 or 6) the parameter determines the time after which the motor will be stopped after end switch contacts are closed.

For gates (parameter 151 set to 3 or 4) the parameter determines time after which the gate will start closing automatically if S2 contacts are opened (if set to 0, gate will not close).

Available settings:	0-600 (0 - 60s) - time		
Default setting:	10 (1s)	Parameter size:	2 [bytes]

155. Motor operation detection

Power threshold to be interpreted as reaching a limit switch.

Available settings:	0 - reaching a limit switch will not be detected		
	1-255 (1-255W) - report interval		
Default setting:	10 (10W)	Parameter size:	2 [bytes]

156. Time of up movement

This parameter determines the time needed for roller blinds to reach the top.

For modes with positioning value is set automatically during calibration, otherwise it must be set manually.

Available settings:	1-90000 (0.01 - 900.00s, every 0.01s) - movement time		
Default setting:	6000 (60s)	Parameter size:	4 [bytes]

157. Time of down movement

This parameter determines time needed for roller blinds to reach the bottom.

For modes with positioning value is set automatically during calibration, otherwise it must be set manually.

Available settings:	1-90000 (0.01 - 900.00s, every 0.01s) - movement time		
Default setting:	6000 (60s)	Parameter size:	4 [bytes]



#16: Specifications

Power supply:	100-240V~ 50/60 Hz
Rated load current:	4.2A for lamps and resistive loads 1.7A for motors with compensated power factor (inductive loads)
Supported motor type:	single-phase AC motors
Required limit switches:	electronic or mechanic
Power consumption:	up to 0.8W
Operating temperature:	0-35°C
Operating humidity:	10-95%RH without condensation
Active element:	micro-gap relay switch μ
For installation in boxes:	$\varnothing \geq 50\text{mm}$, depth $\geq 60\text{mm}$
Radio protocol:	Z-Wave (500 series chip)
Radio signal power:	EIRP up to 6dBm
Radio frequency:	868.4 or 869.8 MHz EU; 908.4 or 916.0 MHz US; 921.4 or 919.8 MHz ANZ; 869.0 MHz RU;
Range:	up to 50m outdoors up to 40m indoors (depending on terrain and building structure)
Dimensions (L x W x H):	42.5 x 38.25 x 20.3 mm
Compliance with EU directives:	RoHS 2011/65/EU RED 2014/53/EU

i NOTE

Radio frequency of individual device must be same as your Z-Wave controller. Check information on the box or consult your dealer if you are not sure.

#17: Regulations

This device complies with Part 15 of the FCC Rules

Operation is subject to the following two conditions:

1. This device may not cause harmful interference
2. This device must accept any interference received, including interference that may cause undesired operation. This equipment has been tested and found to comply with the limits for a Class B digital device, pursuant to part 15 of the FCC Rules. These limits are designed to provide reasonable protection against harmful interference in a residential installation. This equipment generates, uses and can radiate radio frequency energy and, if not installed and used in accordance with the instructions, may cause harmful interference to radio communications. However, there is no guarantee that interference will not occur in a particular installation. If this equipment does cause harmful interference to radio or television reception, which can be determined by turning the equipment off and on, the user is encouraged to try to correct the interference by one or more of the following measures:

- Reorient or relocate the receiving antenna.
- Increase the separation between the equipment and receiver.
- Connect the equipment into an outlet on a circuit different from that to which the receiver is connected.
- Consult the dealer or an experienced radio/TV technician for help.

Changes and modifications not expressly approved by the manufacturer or registrant of this equipment can void your authority to operate this equipment under Federal Communications Commission's rules.

Industry Canada (IC) Compliance Notice

This device complies with Industry Canada license-exempt RSSs. Operation is subject to the following two conditions: (1) this device may not cause interference, and (2) this device must accept any interference, including interference that may cause undesired operation of the device.

Cet appareil est conforme aux normes d'exemption de licence RSS d'Industry Canada. Son fonctionnement est soumis aux deux conditions suivantes : (1) cet appareil ne doit pas causer d'interférence et (2) cet appareil doit accepter toute interférence, notamment les interférences qui peuvent affecter son fonctionnement.

Legal Notices

All information, including, but not limited to, information regarding the features, functionality, and/or other product specification are subject to change without notice. Fibaro reserves all rights to revise or update its products, software, or documentation without any obligation to notify any individual or entity.

FIBARO and Fibar Group logo are trademarks of Fibar Group S.A. All other brands and product names referred to herein are trademarks of their respective holders.

DGT Warning Statement

Article 12

Without permission, any company, firm or user shall not alter the frequency, increase the power, or change the characteristics and functions of the original design of the certified lower power frequency electric machinery.

Article 14

The application of low power frequency electric machineries shall not affect the navigation safety nor interfere a legal communication, if an interference is found, the service will be suspended until improvement is made and the interference no longer exists.

第十二條

經型式認證合格之低功率射頻電機，非經許可，公司、商號或使用者均不得擅自變更頻率、加大功率或變更原設計之特性及功能。

第十四條

低功率射頻電機之使用不得影響飛航安全及干擾合法通信；經發現有干擾現象時，應立即停用，並改善至無干擾時方得繼續使用。前項合法通信，指依電信法規定作業之無線電通信。低功率射頻電機須忍受合法通信或工業、科學及醫療用電波輻射性電機設備之干擾。

Declaration of conformity



Hereby, Fibar Group S.A. declares that the device is in compliance with the essential requirements and other relevant provisions of Directive 2014/53/EU. The full text of the EU declaration of conformity is available at the following internet address: www.manuals.fibaro.com

WEEE Directive Compliance



Device labelled with this symbol should not be disposed with other household wastes. It shall be handed over to the applicable collection point for the recycling of waste electrical and electronic equipment.

