

# ***User Manual***

## **E1**



# Contents

Security Warning.....	III
What's In the Box.....	IV
1. Overview.....	1
1.1. Key Features.....	1
1.2. Physical Description.....	2
1.3. Wireless Connectivity.....	4
2. Setting Up Your E1 System.....	5
2.1. Install the Rechargeable Battery Into Your Camera.....	5
2.2. Connect Your Base Station to the Internet.....	6
2.3. Download Foscam App.....	7
2.4. Get a Free Foscam Account.....	7
2.5. Add the Base Station to an Existing Foscam Account.....	8
2.6. View Your Video Footage.....	8
2.7. Place / Mount Your Camera.....	9
2.7.1. Place Your Camera on a Flat Surface.....	9
2.7.2. Mount Your Camera to the Wall.....	9
2.8. Charge Your Battery.....	10
2.9. Sync Your Camera with the Base Station.....	11
3. View Your Content.....	13
3.1. View the Devices Page.....	13
3.2. Watch Live.....	14
3.3. Record Clips From Live Video.....	16
3.4. Take a Snapshot From Live Video.....	19
3.5. Talk and Listen.....	21
3.6. View Alerts.....	22
3.7. Cloud Recording.....	23
3.8. View Recordings In Foscam Cloud.....	24
4. Device Settings.....	26
4.1. Active / Deactivate 7 Day Cloud Storage.....	26
4.2. Turn On the Siren Manually.....	28
4.3. Turn Off the Siren Manually.....	29
4.4. Rename Your Base Station.....	31
4.5. View Base Station Information.....	32
4.6. Sync Time.....	34
4.7. Security Settings.....	35
4.8. Upgrade Base Station Firmware.....	36
4.9. Restart Base Station.....	38
4.10. Delete Base Station.....	39
4.11. Camera Settings.....	41

4.11.1 Rename Your Camera.....	41
4.11.2 View Camera Information.....	42
4.11.3 Change Speaker Volume.....	44
4.11.4 Change Video Quality.....	46
4.11.5 Adjust the Power Frequency.....	48
4.11.6 Turn On / Off the Camera LED.....	50
4.11.7 Turn On / Off the Voice Prompt.....	53
4.11.8 Upgrade Camera Firmware.....	55
4.11.9 Delete a Camera.....	57
4.12. Forgotten Base Station User Name & Password?.....	60
5. App Settings.....	61
5.1. View the Live Video Only In WiFi Environment.....	61
5.2. Push Messages.....	62
5.3. Devices List Settings.....	63
5.4. Sign Out.....	64
6. Appendix.....	67
6.1. CE & FCC.....	67
6.2. WARRANTY.....	68
6.3. Statement.....	71
7. Obtaining Technical Support.....	73

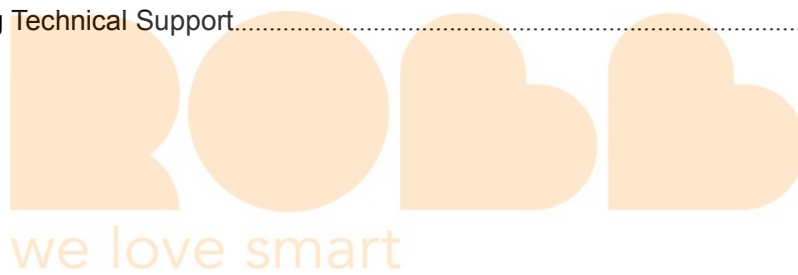

# Security Warning

---

- Please change the password of your Base Station regularly, using a combination of numbers, letters and special characters.
- We recommend that you regularly update your camera and Base Station to the latest available software and firmware versions to help ensure the best experience for your system.

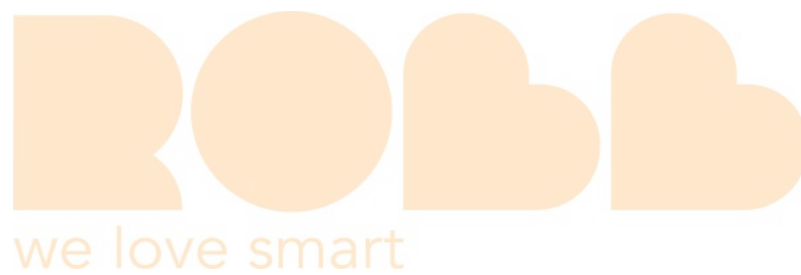

# What's In the Box

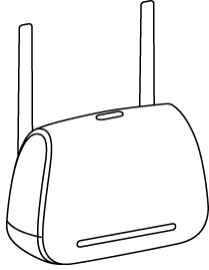

E1 Base Station

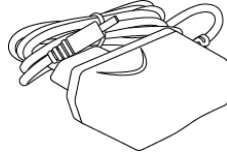

E1 Base Station  
Power Adapter

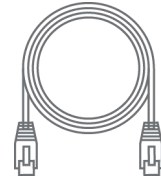

Ethernet Cable



E1 Camera



E1 Camera  
Power Adapter



Camera USB Power Cable

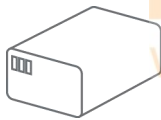

Rechargeable Battery



Magnetic Wall Mount

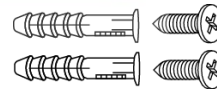

Mounting Screws & Anchors

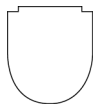

Single-sided Adhesive Tape

# 1. Overview

## 1.1. Key Features

- ◆ **HD Video:** 2.0 Mega-Pixel, enjoy sharp, detailed video.
- ◆ **Human Detection:** The human detection feature lets you set the camera to send alerts only when human motion is detected. This cuts down inessential alerts such as those caused by pets, drapes under an AC vent, or foliage swaying in wind.
- ◆ **IR Range:** IR LEDs for IR range up to 8m (26ft).
- ◆ **Rechargeable Battery:** Cameras include rechargeable battery that support fast charging and long lasting batteries. Easily swap out battery and power up in seconds without having your cameras offline.
- ◆ **Local Backup:** Use USB storage for backup.
- ◆ **Wire-free:** Free of power cords and wiring hassles, allowing you to easily place cameras wherever you want and monitor your home from every angle.
- ◆ **Weatherproof:** Cameras are weatherproof so you can place them anywhere-indoors and out.
- ◆ **2-Way Audio:** Built-in mic and speaker enable push-to-talk capability, so you can listen in and talk back.
- ◆ Supports push messages.
- ◆ **7 Days of Free Cloud Recordings:** We provide free cloud storage for the life of the cameras. We store a rolling 7 days of recordings that are created when the camera detects motion

## 1.2. Physical Description

### E1 Base Station

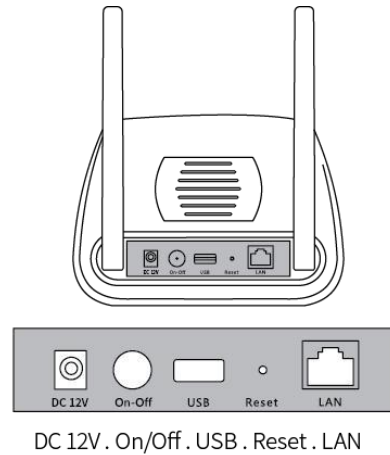
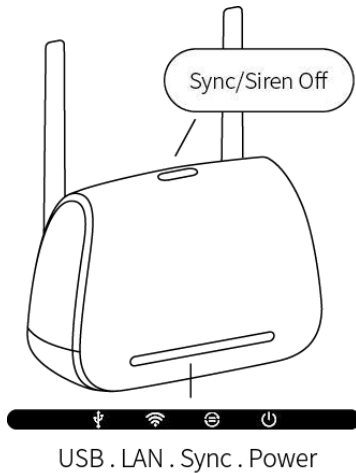

#### Sync / Siren Off button

- Press the button to sync camera with Base Station.
- Press the button to turn off the siren manually.



**Green:** The Base Station is connected to an external USB Storage Device.

**Blinking green:** The system is recording.

**Amber:** The external USB Storage Device is full or disabled.

**Off:** No USB Storage Device is inserted.



**Green:** The Base Station is connected to the Internet.

**Amber:** The Base Station is connected to the router but no Internet connection has been established.

**Off:** The Base Station is not connected to a router.



**Green:** Camera(s) are connected to the Base Station.

**Blinking green:** The Base Station is attempting to sync with a camera.

**Off:** No camera are currently connected to the Base Station.



**Green:** The Base Station is powered on.

**Off:** The Base Station is powered off.

## E1 Camera

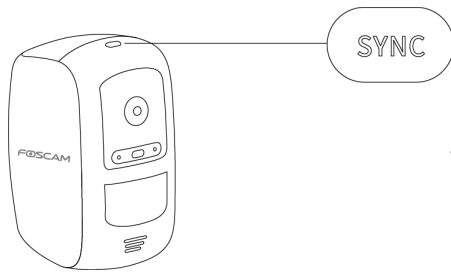

### **Sync Button:**

Press this button to sync the E1 with the Base Station.

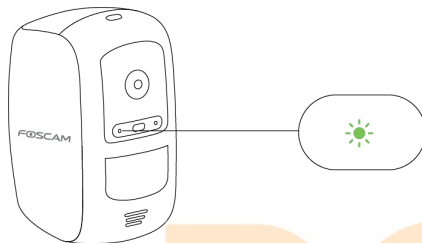

**Green Slow Blinking :** Sync in process..

**Solid Green Then Off:** Sync process completed.

**Blinking Amber Rapidly:** Fail to sync.

**Blinking Amber Slowly Then Off:** The camera's battery level is low.

**Off:** Camera is on standby or the battery is depleted.

we love smart



### 1.3. Wireless Connectivity

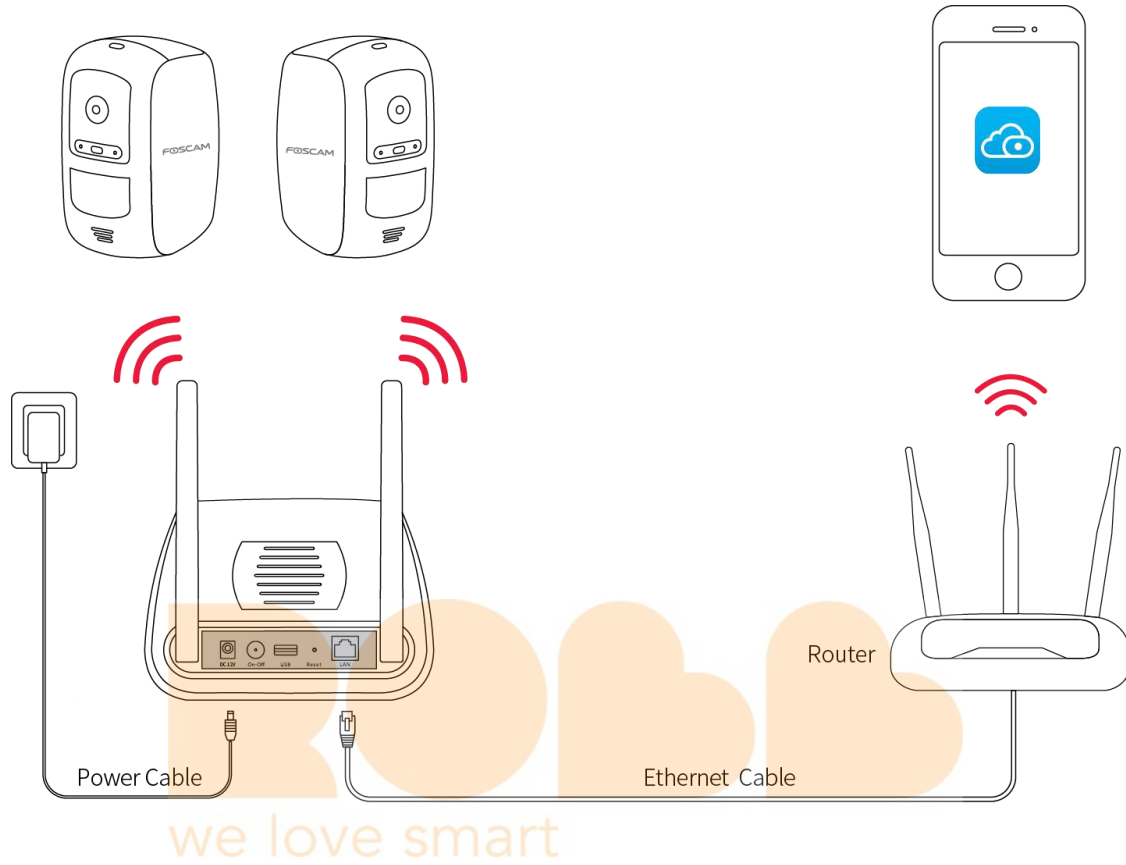

## 2. Setting Up Your E1 System

### 2.1. Install the Rechargeable Battery Into Your Camera

- a. Unlock the Rechargeable Battery compartment by pressing and holding the latch.
- b. The battery door will open automatically.



- c. Align the battery contacts.
- d. Insert the Rechargeable Battery.

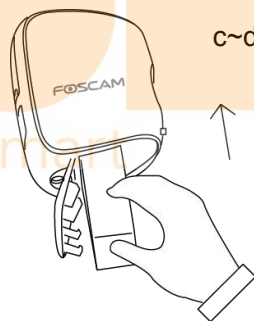

- e. Close the battery door.

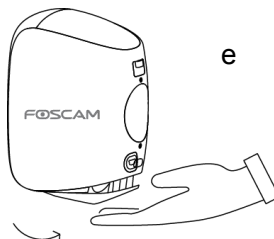

When the in-package camera is powered on, its LED light will blink green repeatedly, indicating that it is in the process of syncing with the Base Station.

**Note:** Please fully charge the battery before first use.

## 2.2. Connect Your Base Station to the Internet

1. Connect the Base Station to your router with an Ethernet cable.

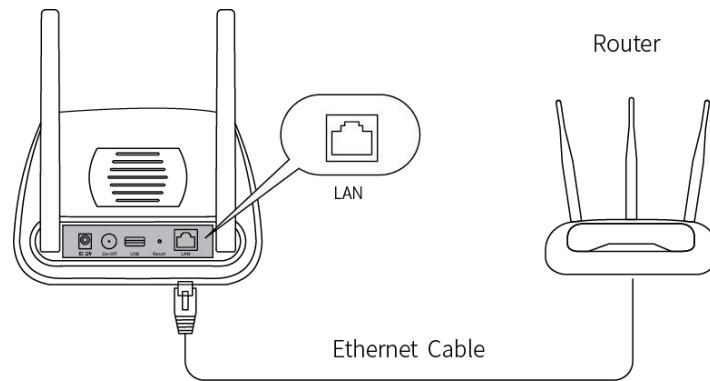

2. Plug the Base Station Power Adapter into an electrical outlet.

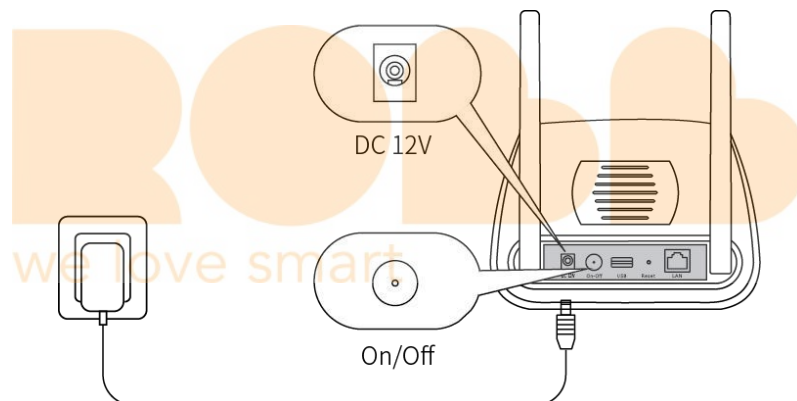

3. Press the **On/Off** button, and wait until the power and Internet lights turn green. With a minute, the camera will connect to the Base Station automatically.  
A green LED on the camera will blink rapidly while syncing. The camera LED will then turn off, and the Sync Status LED of the Base Station will turn solid green, indicating that sync is successful and the camera will announce "Base Station connection succeeded".

Note: Make sure your smartphone is on the same network as the router. It will need to be connected to the 2.4GHz WiFi channel.

## 2.3. Download Foscam App

- To download the free Foscam App, simply scan the QR Code below.
- You can also search for "Foscam" in the App Store or Google Play store to download and install Foscam App as well.



With the Foscam App, you can turn your iOS or Android smartphone into a monitoring center for your security system.

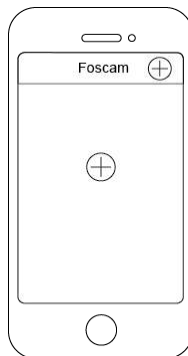

## 2.4. Get a Free Foscam Account

- **To create a new Foscam account**  
launch the Foscam App from your smartphone, tap the **Sign Up** button, and follow the onscreen instructions.
- **Add the Base Station to an existing Foscam Account**  
a. If you already have a Foscam Account, log in and tap .



- b. Follow the onscreen instructions.

## 2.5. Add the Base Station to an Existing Foscam Account

1. Tap the Foscam icon  on your mobile phone, then login to your Foscam Account.
2. Tap .

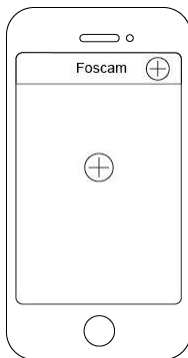

3. Select **Base Station**, Tap **Next** to scan the QR code of the Base Station, or tap **Alternate Setup** to add the Base Station.



4. Follow the onscreen instructions.

## 2.6. View Your Video Footage

When you launch the Foscam App, the devices page will display. To view and listen in on a live feed, tap or click **Live** on the camera feed image. View your camera's alert video recordings in the Foscam Cloud by tapping the timebar in the live page.

Your system is now set up and ready to go.

## 2.7. Place / Mount Your Camera

### 2.7.1. Place Your Camera on a Flat Surface

You can place your camera on a flat surface (desk, shelf, Table, etc.)

1. Apply the single-sided adhesive tape provided in the package to the bottom of the camera.

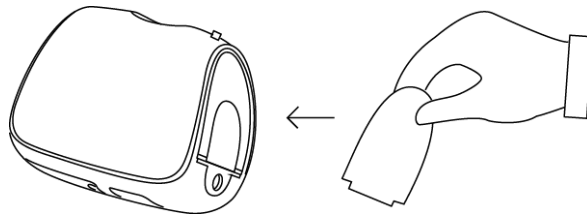

2. Place your camera on a flat surface and position the camera to monitor the area that you would like to.

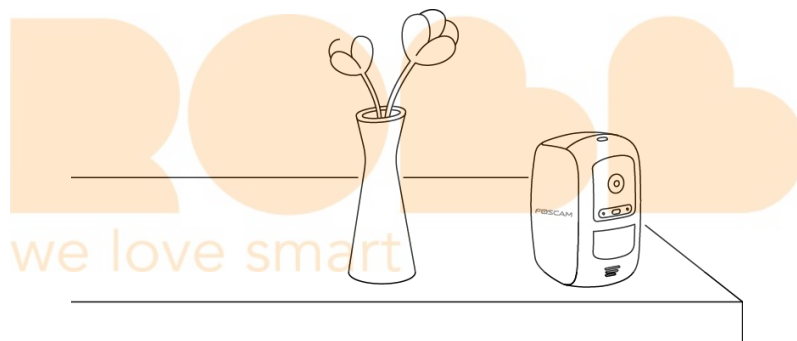

### 2.7.2. Mount Your Camera to the Wall

Note:

Before mounting the Magnetic Wall Mount, please ensure that the camera is positioned towards the precise area you would like to monitor.

1. Fasten the mounting screw into the wall.

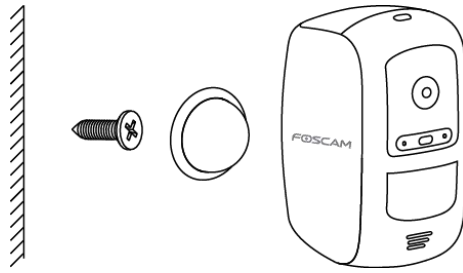

2. Hang the Magnetic Wall Mount from the screw.



## 2.8. Charge Your Battery

1. Place the camera indoors. If the camera is currently mounted to a wall, remove it from the Magnetic Wall Mount.

Note: If you are using the camera outside, bring it inside while charging the battery.

2. Connect the power adapter and cable as shown below:

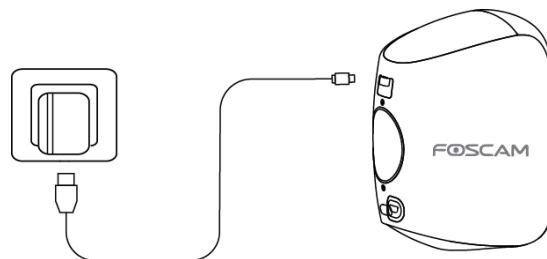

3. The camera LED light will stay solid green when the battery is fully charged.

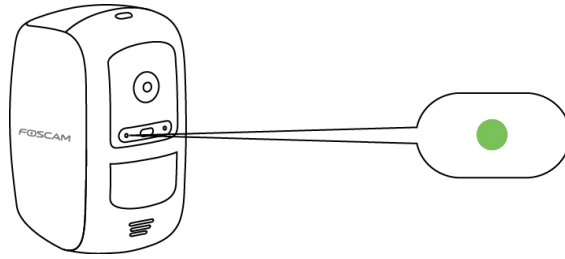

## 2.9. Sync Your Camera with the Base Station

When adding additional Foscam E1 cameras to your system, you will need to individually sync them to the Base Station.

1. Please insert the Rechargeable Battery into the camera.
2. Place the camera within 1 to 3 feet (30 to 100 centimeters) of the Base Station.

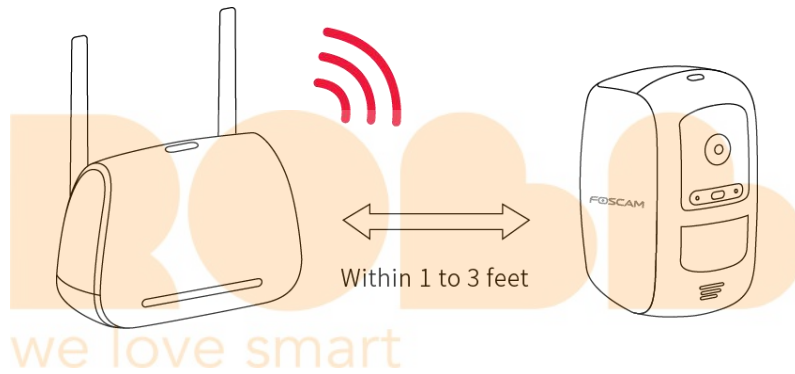

3. Press and hold the **Sync** button on the top of the Base Station for about two seconds and then release it.

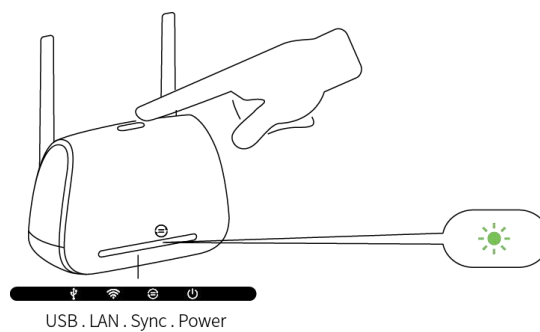

4. When Sync Status LED blink green, press the **Sync** button on top of the camera for about two seconds and then release it.



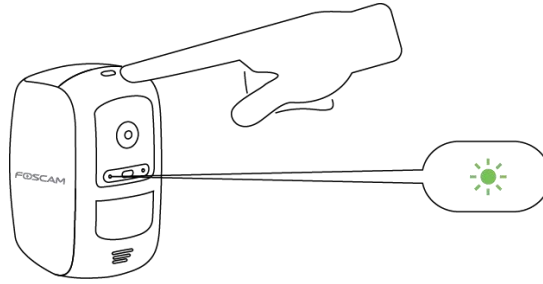

A green LED on the camera will blink rapidly while syncing. The camera LED will then turn off, and the Sync Status LED of the Base Station will turn solid green, indicating that sync is successful and the camera is ready for viewing!

Note: If the camera LED blinks an Amber color, then sync has failed. Please repeat the sync process again and ensure that the camera is within 1-3 ft. of the Base Station.

## Syncing more than one camera?

Repeat steps 1 through 4 for each camera.

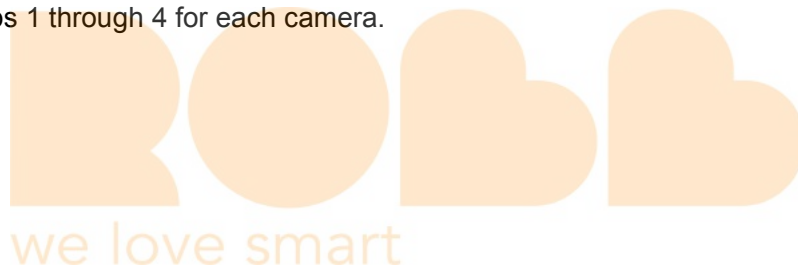

# 3. View Your Content





To view and listen to a live feed, tap **Live** on the camera feed image.

To view your camera's alarm video recordings in cloud by tapping the timebar in the live page.

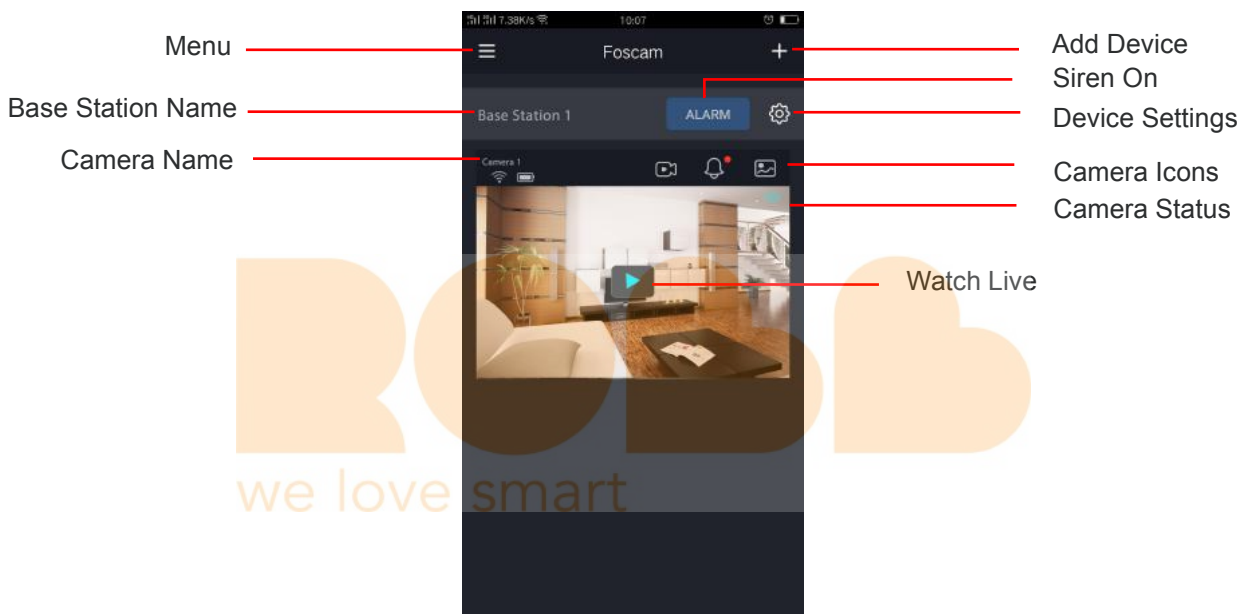
## 3.1. View the Devices Page

When you launch the Foscam app, the devices page displays.



Camera Icons	
	WiFi Signal
	Battery
	Cloud History
	Alerts
	Album

## 3.2. Watch Live

You can view a livestream of your camera at any time.

1. Tap the **Foscam** icon  on your mobile device.

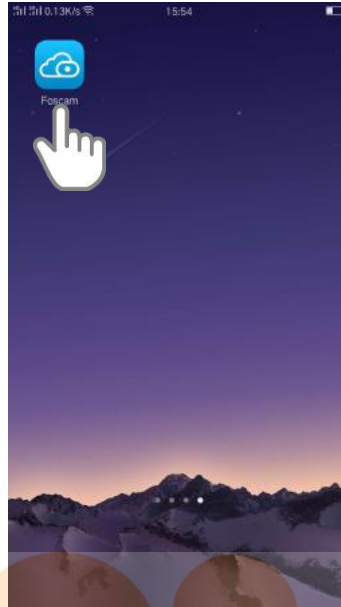





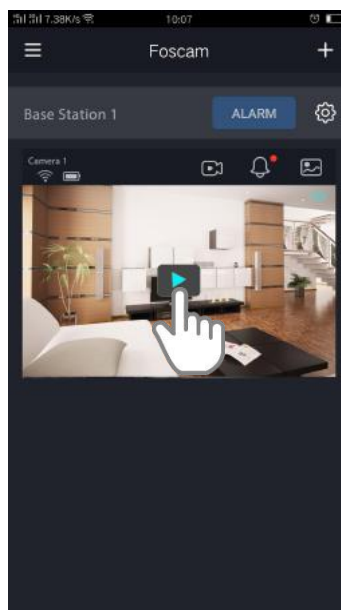

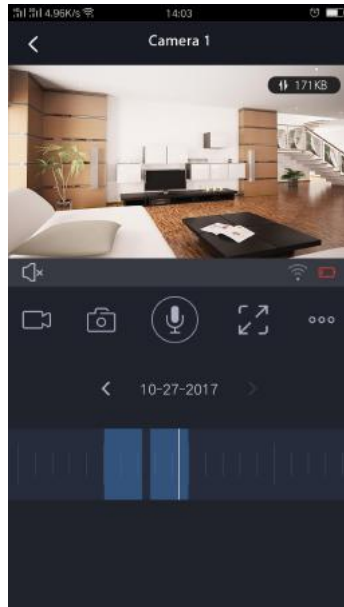

The Devices page displays.

2. Tap **Live**  to view and listen to a live video.



A row of live feed icons displays below the live stream image for the camera.



Icons	
	Back
	Speaker / Mute the audio
	Record video manually
	Snapshot
	Two-way audio
	Full screen
	More

On this screen, you can listen to a livestream, record clips, take a snapshot, activate two-way talk or full screen.

If you want to catch the smaller details, pinch and drag any image as you do with photos on your smartphone.

3. To stop viewing and listening to the live feed, tap the **Back**  icon.

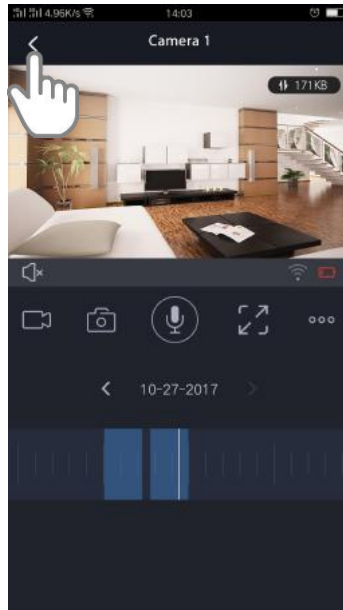

### 3.3. Record Clips From Live Video

To record a short clip of the event to the cloud.

1. Tap the **Foscam** icon  on your mobile device.

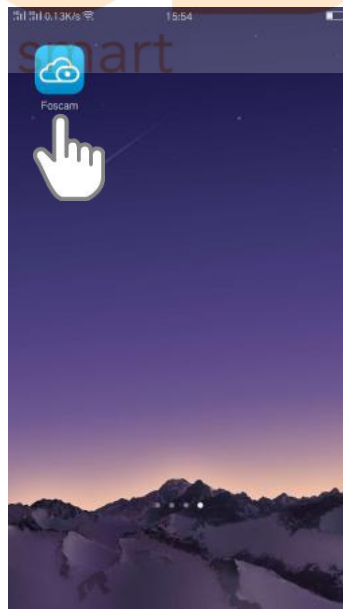

The Devices page displays.

2. Tap **Live**  to view and listen to a live video.

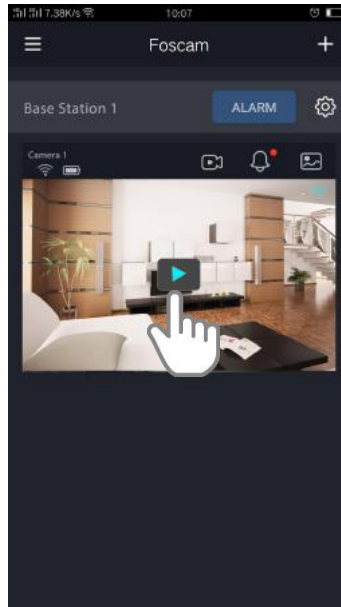

A row of live video icons displays below the live stream image for the camera.

3. Tap **Recording**  to start recording.

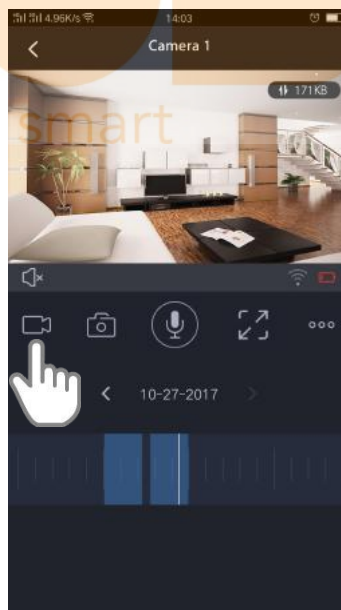

This icon turns blue to indicate that you are recording the live feed, and the recording item will be showed on the middle of the live .

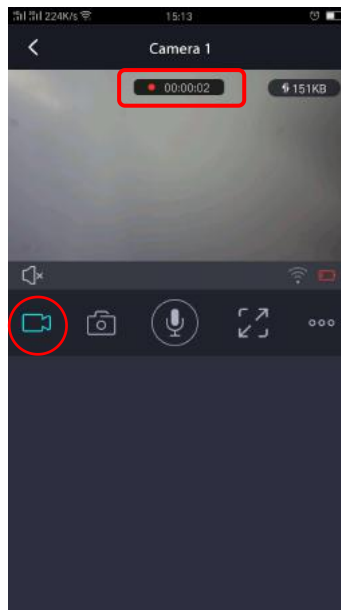

4. Tap **Recording**  to stop recording.

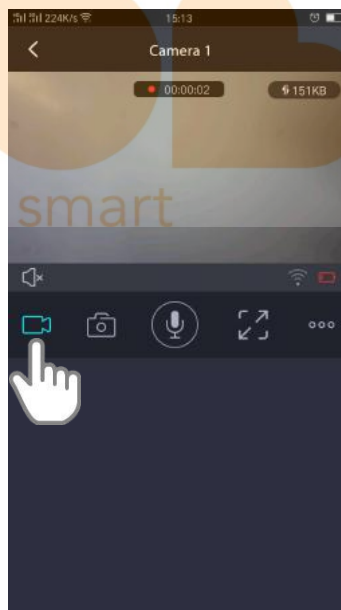

The recording is saved in your Foscam cloud.

### 3.4. Take a Snapshot From Live Video

1. Tap the **Foscam** icon  on your mobile device.

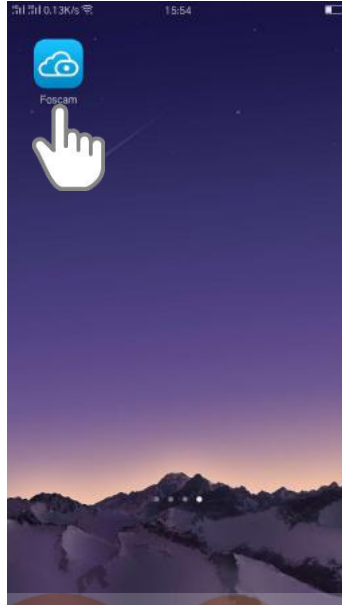

The Devices page displays.

2. Tap Live  to view and listen to a live video.

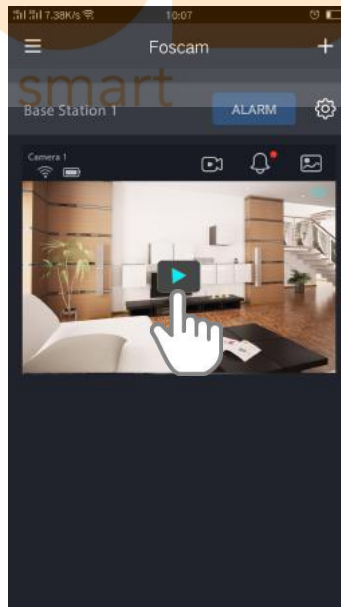

A row of live video icons displays below the live stream image for the camera.



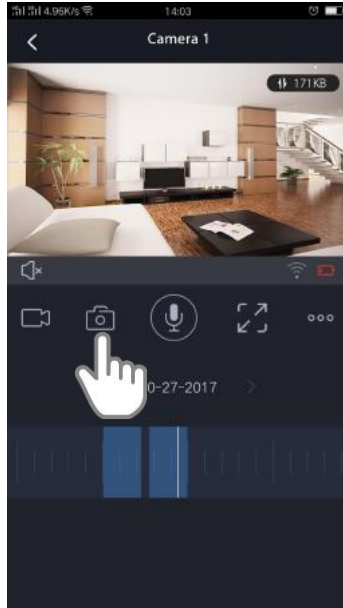

3. Tap Snapshot 

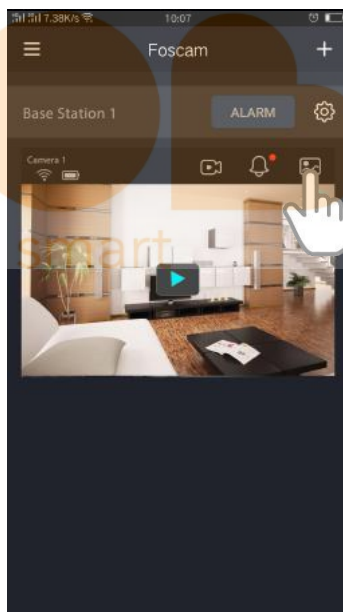

The snapshot is saved in **Album**.



Also, you can view it in Sidebar  > Album .

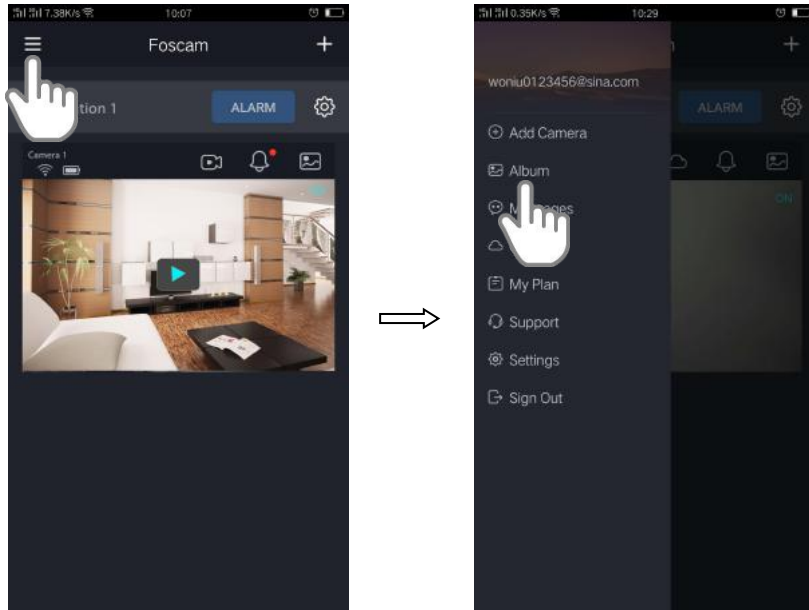

### 3.5. Talk and Listen

1. Tap the Foscam icon  on your mobile device.

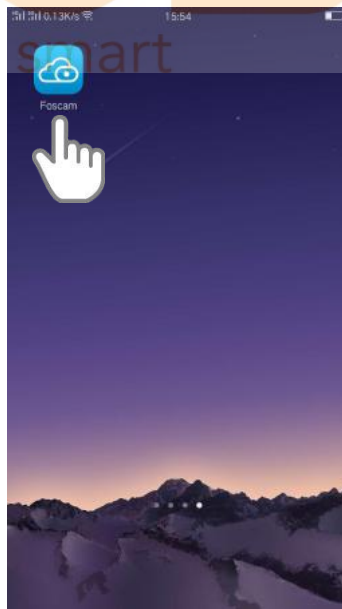

The Devices page displays.

2. Tap Live  to view and listen to a live video.

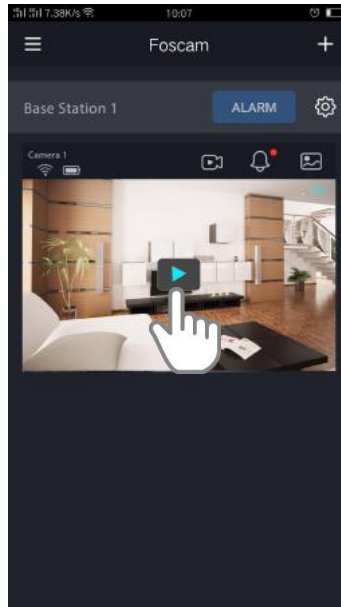

A row of live video icons displays below the live stream image for the camera.

3. Press and hold the  button and speak.

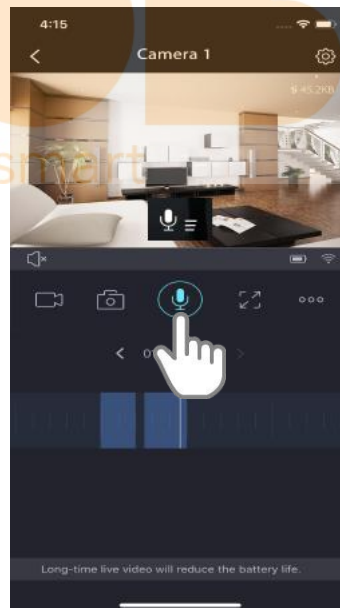

When the button is bright blue, two-way audio is ready.

### 3.6. View Alerts

You can view all alerts of the system, for example motion detection.

1. Tap the **Foscam icon**  on your mobile device.

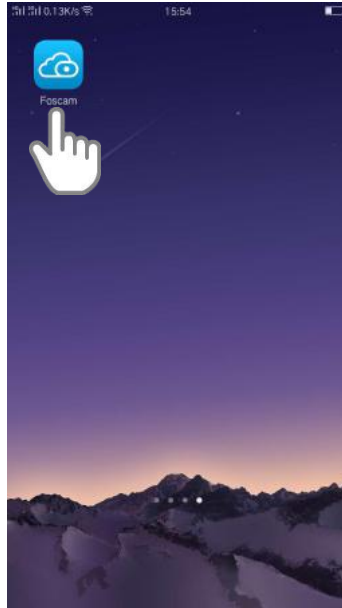

The Devices page displays.

2. Tap  on the live video to view alerts.

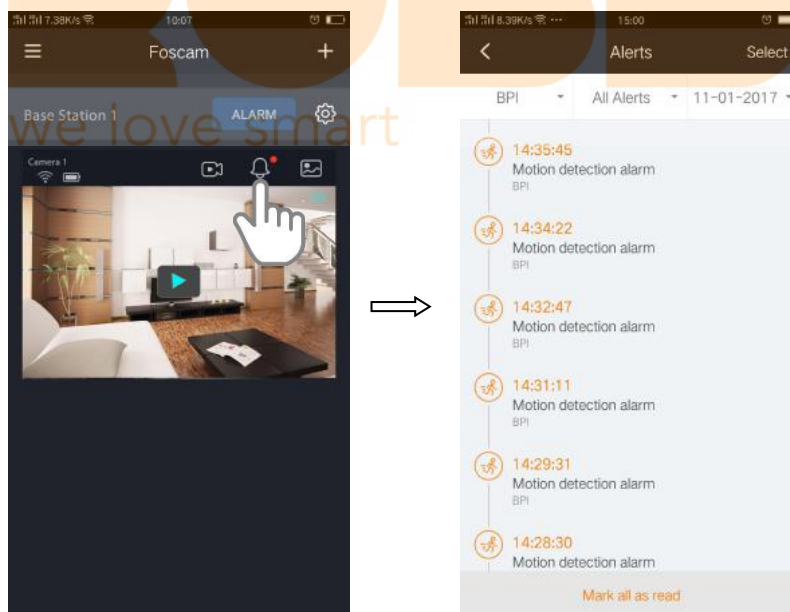

### 3.7. Cloud Recording

With cloud recording, camera's alarm video recordings are sent to the cloud for secure

storage.

You can access these recordings from anywhere you are using a mobile phone. All recordings are encrypted with the user name and password which you have created, no one else can access.

We provide free cloud storage for the life of the cameras. We store a rolling 7 days of recordings that are created when the camera detects motion. You can connect up to 4 cameras free of charge. For how to active 7 Day Cloud Storage, please refer to [Active 7 Day Cloud Storage](#).

You can download recordings and save them to the external USB storage device for long-term storage.

### 3.8. View Recordings In Foscam Cloud

View your video recordings in cloud by tapping **Cloud History** .

1. Tap the **Foscam** icon  on your mobile device.

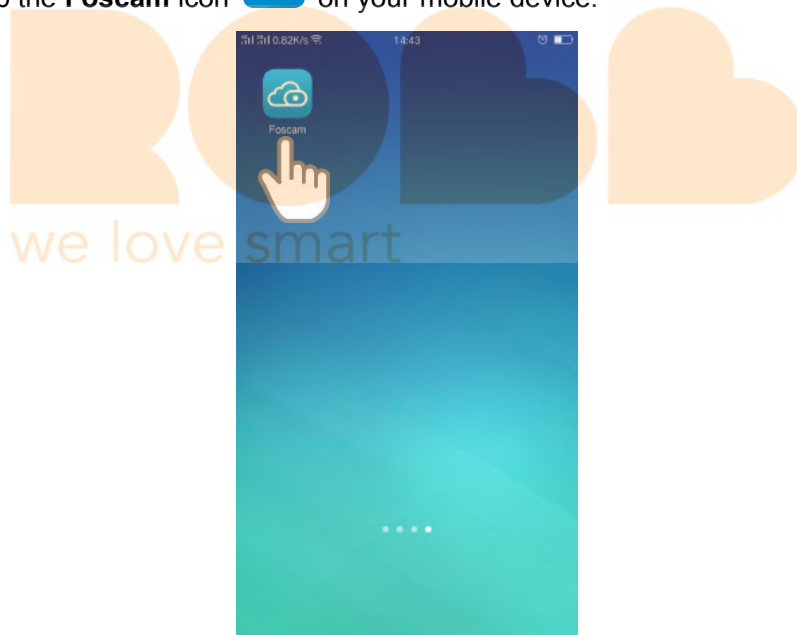

The Devices page displays.

1. Tap **Cloud History**  to view and listen to a recorded video.

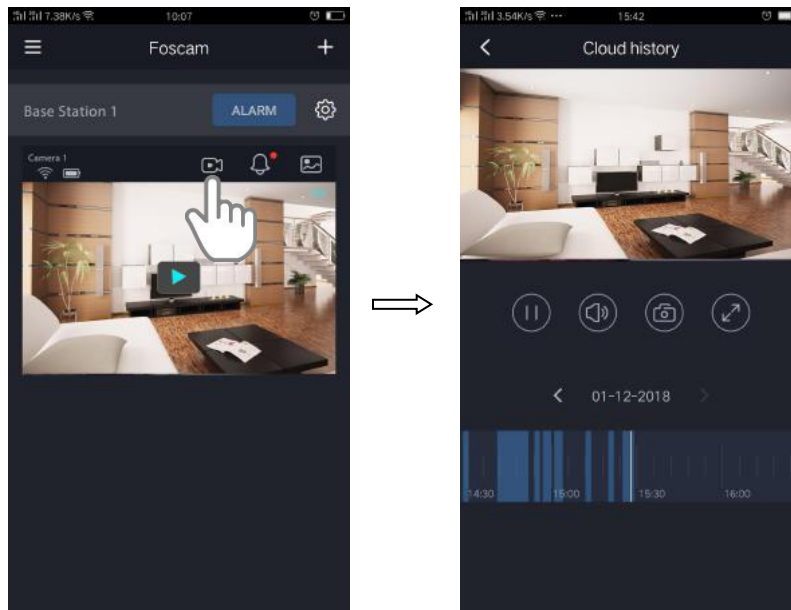

Note:

Days in which a video clip was recorded are indicated with an amber circle.

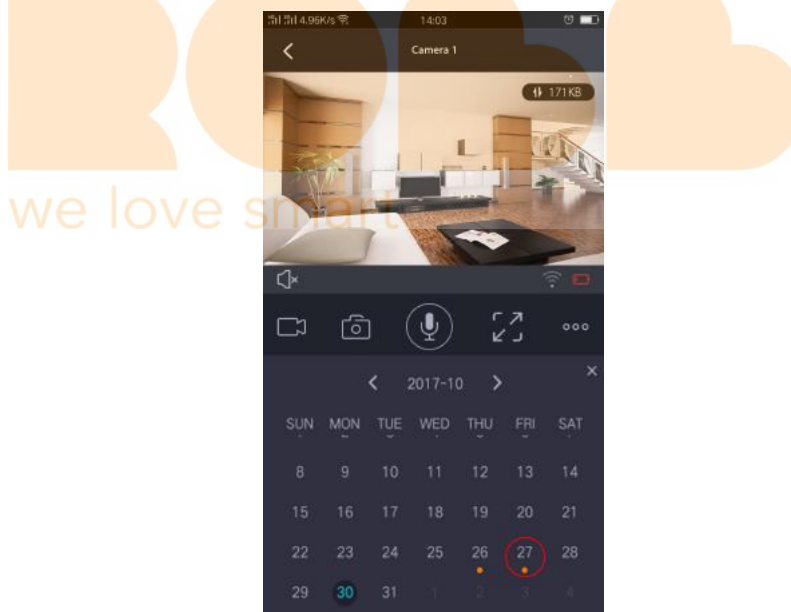

# 4. Device Settings

## 4.1. Active / Deactivate 7 Day Cloud Storage

1. Tap the **Foscam** icon  on your mobile device.

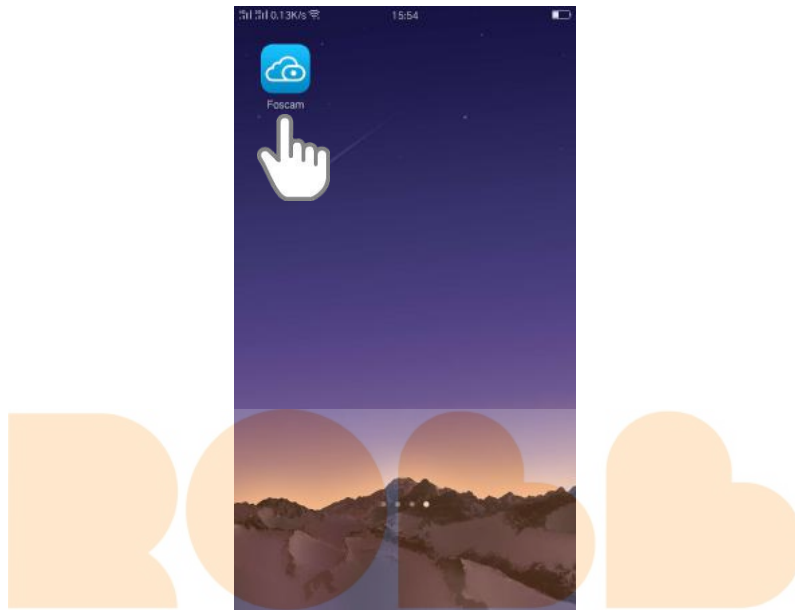

The Devices page displays.

2. Tap **Setting**  > **My Plan**  > **Active Now**, the cameras are active.

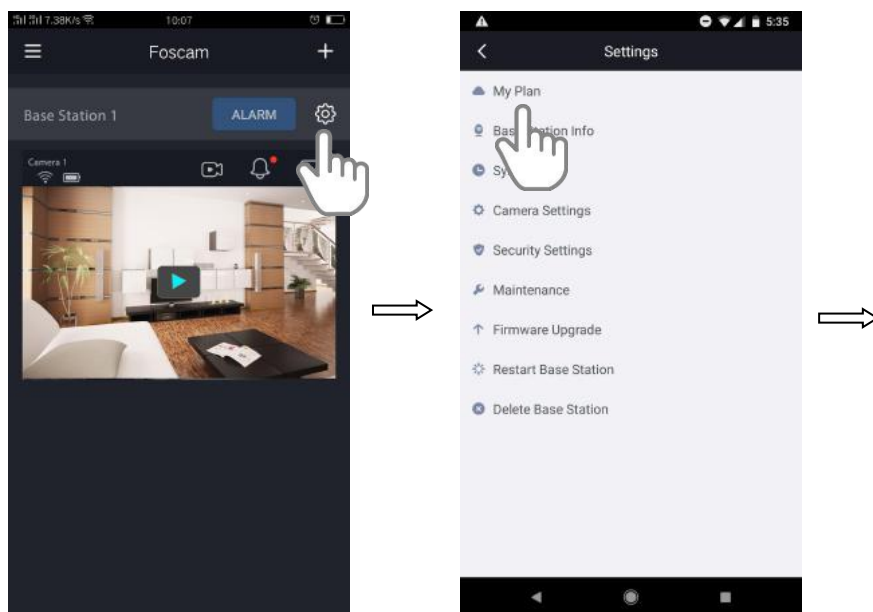

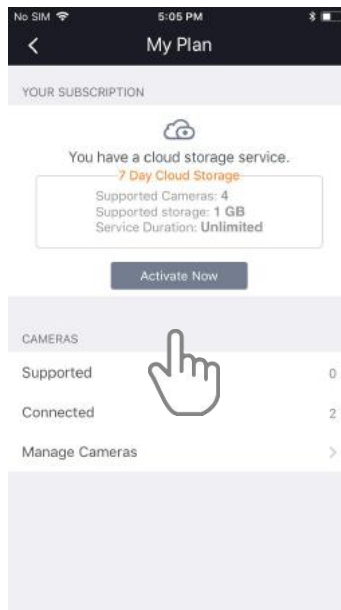

3. Tap **Manage Cameras** conform the active cameras.

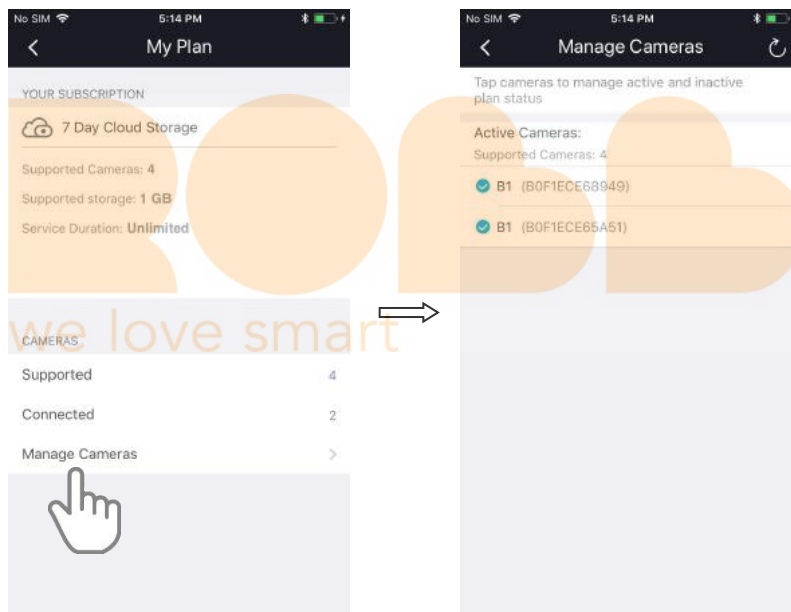



4. To **DEACTIVATE** the cameras. Tap the active cameras, a Dialog Box will be displayed, Tap **Continue**.

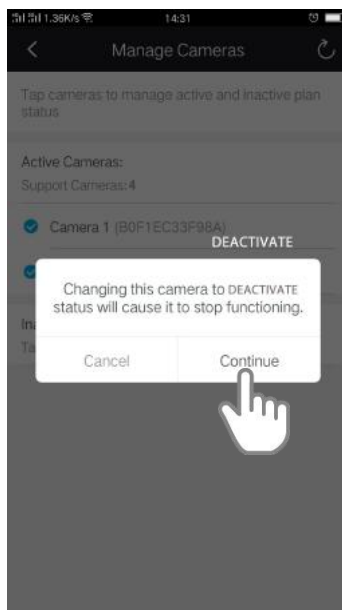

We provide free cloud storage for the life of the cameras. We store a rolling 7 days of recordings that are created when the camera detects motion.

## 4.2. Turn On the Siren Manually

**WARNING:** This may get loud and possibly damage your hearing if you are too close to the Base Station.

1. Tap the **Foscam** icon  on your mobile device.

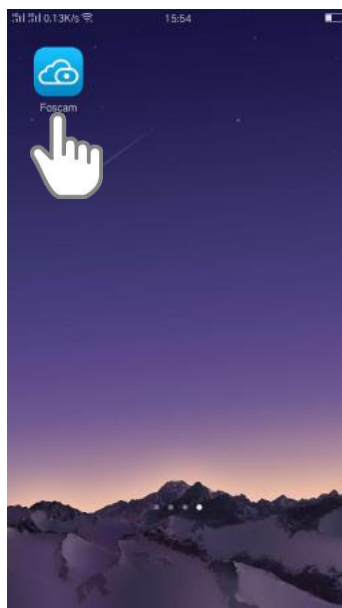

The Devices page displays.

2. Tap **Alarm**  > **Yes** to turn on the siren manually.

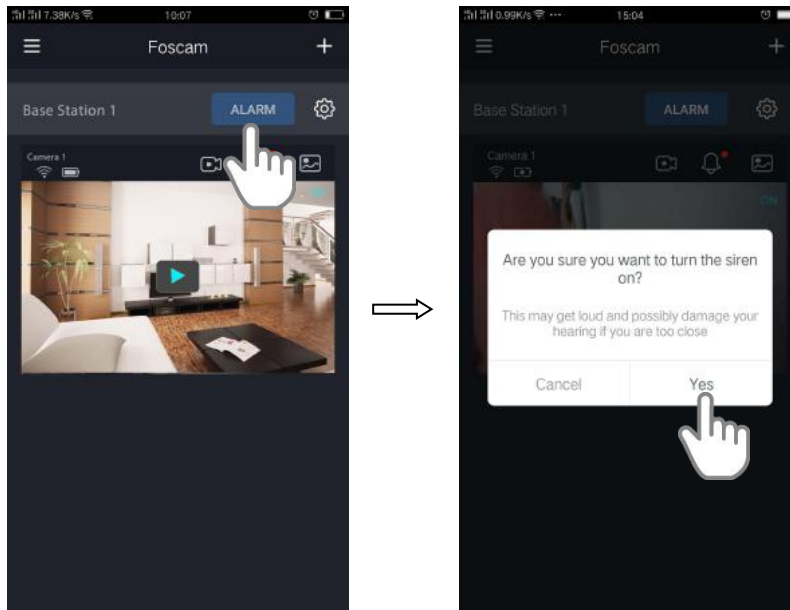

### 4.3. Turn Off the Siren Manually

- **To turn off the siren when near the Base Station**

Press the **Sync / Siren Off** button on the top of the Base Station to stop the siren.

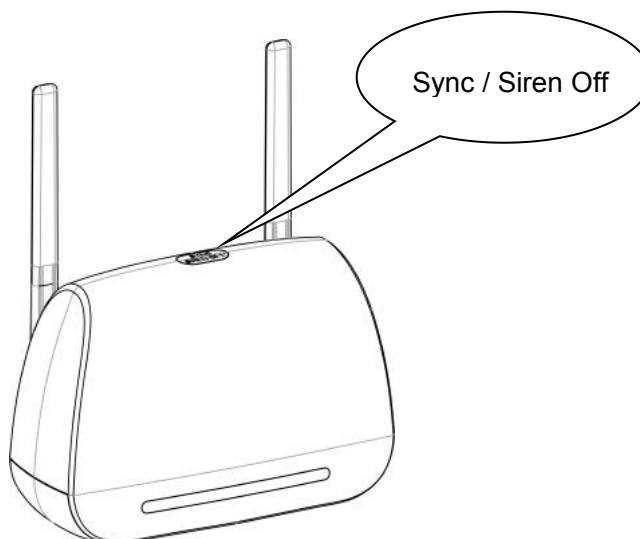

- **To turn off the siren remotely**

1. Tap the **Foscam** icon  on your mobile device.

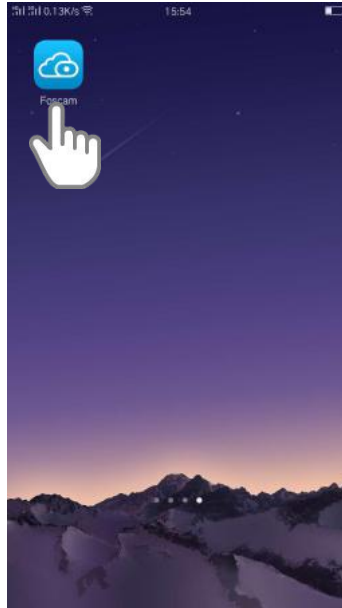

The Devices page displays.

2. Tap **Close Siren** to stop the siren.

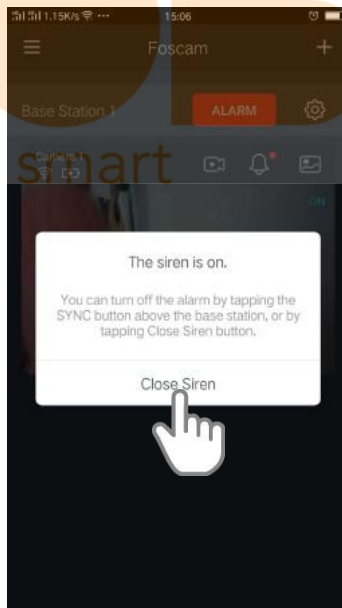

## 4.4. Rename Your Base Station

1. Tap the **Foscam** icon  on your mobile device.

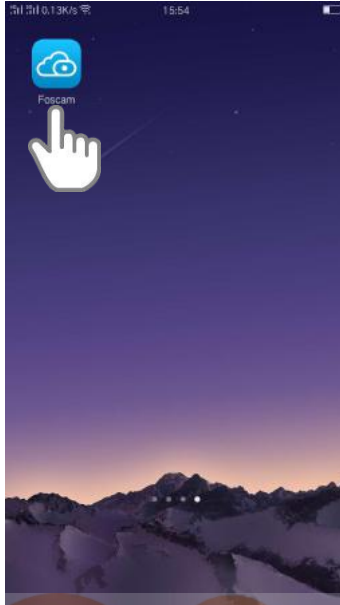

The Devices page displays.

2. Tap **Setting**  > **Base Station Info** .

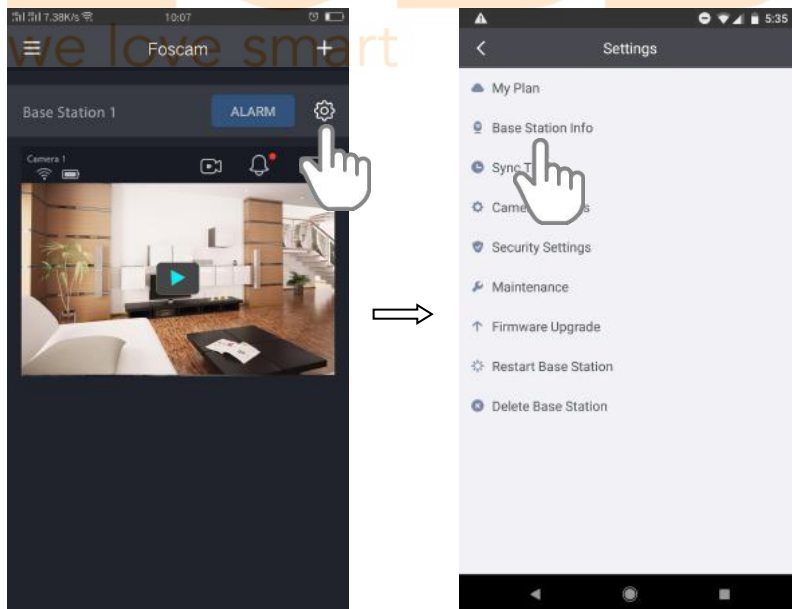

3. Enter a new name for the Base Station.



The new name will be displayed in the app.

## 4.5. View Base Station Information

You will view Base Station name, Model, UID, MAC ID and the firmware level.

1. Tap the **Foscam** icon  on your mobile device.

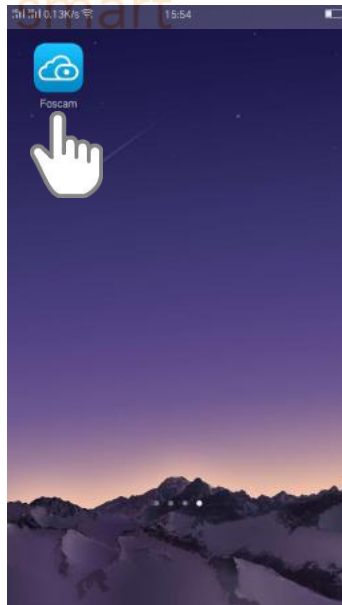

The Devices page displays.

2. Tap **Setting**  > **Base Station Info**  .

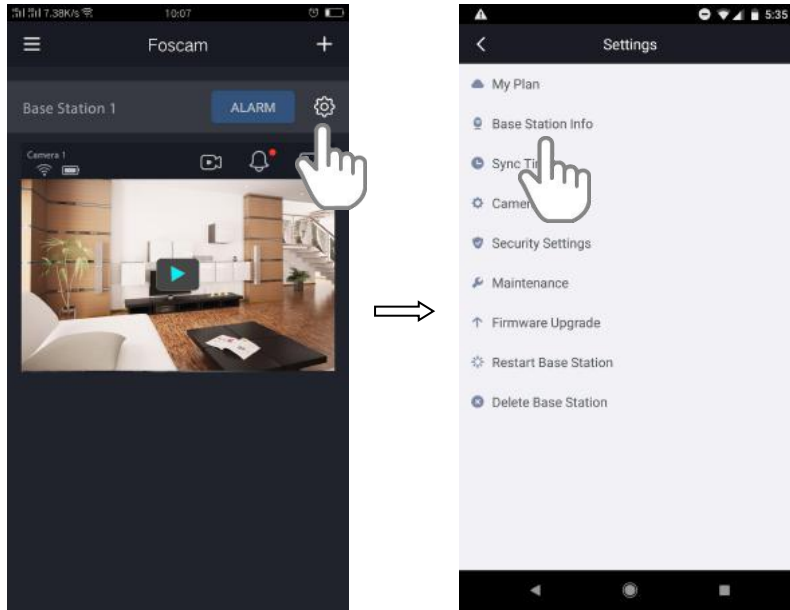

3. You will view Base Station name, Model, UID, MAC ID and the firmware version on this page.

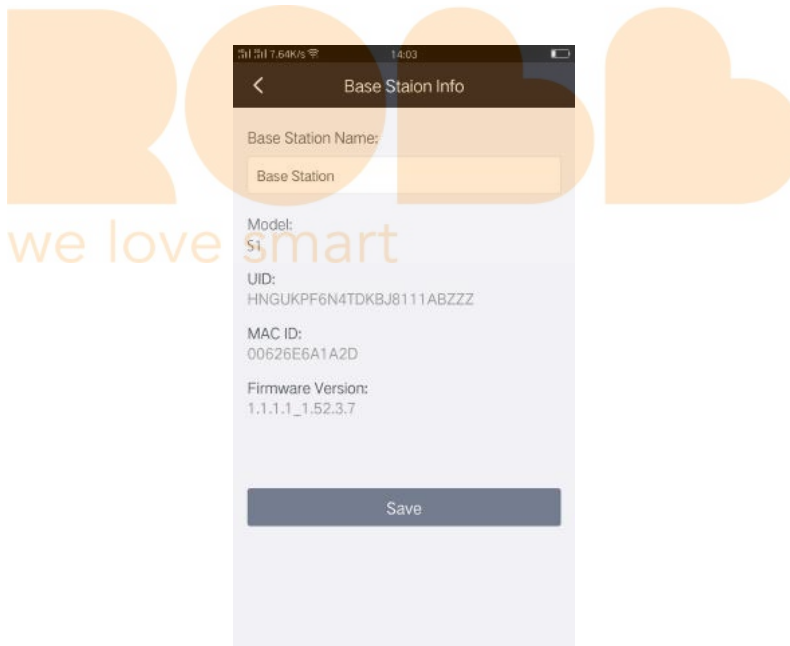

## 4.6. Sync Time

1. Tap the **Foscam** icon  on your mobile device.

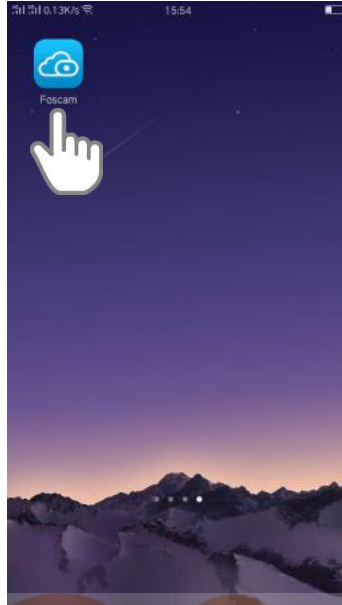

The Devices page displays.

2. Tap Setting  > Sync Time .

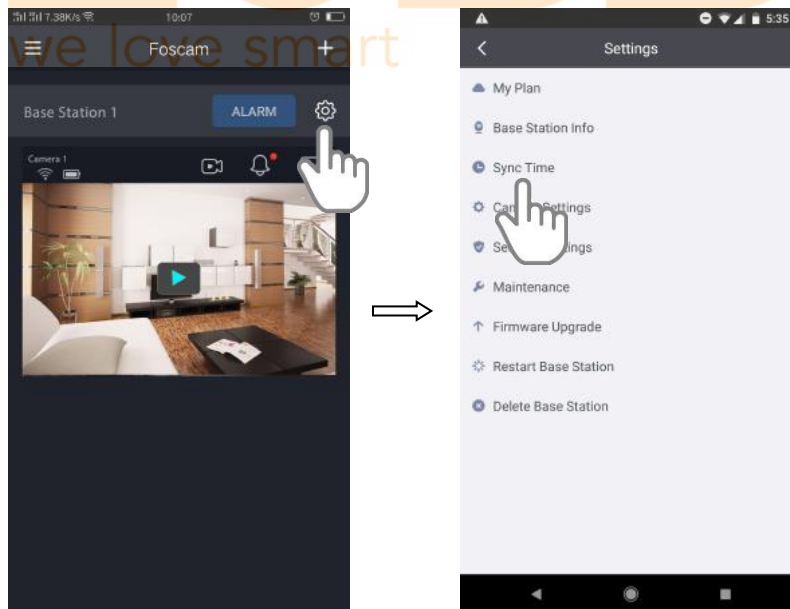

The camera time is synced with the local time.

## 4.7. Security Settings



### Security Warning:

We recommend that you change the password of your Base Station regularly, using a combination of numbers, letters and special characters.

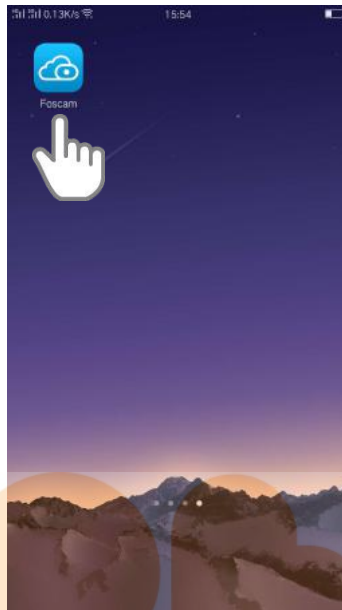
1. Tap the **Foscam** icon  on your mobile device.



The Devices page displays.

2. Tap **Setting**  > **Security Settings** .

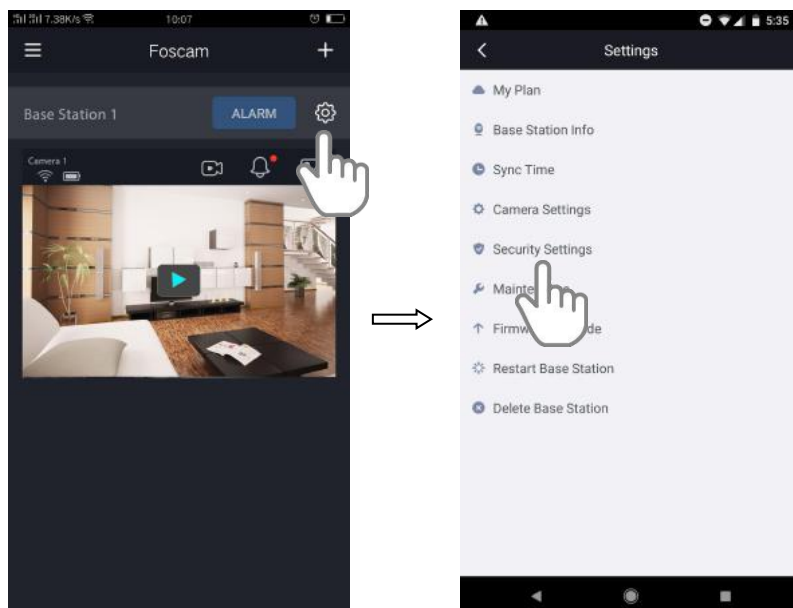



3. Change the Base Station username and password as below figure:

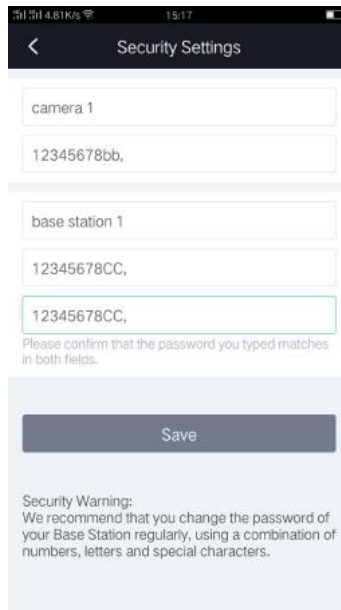

4. Tap **Save** to save it.

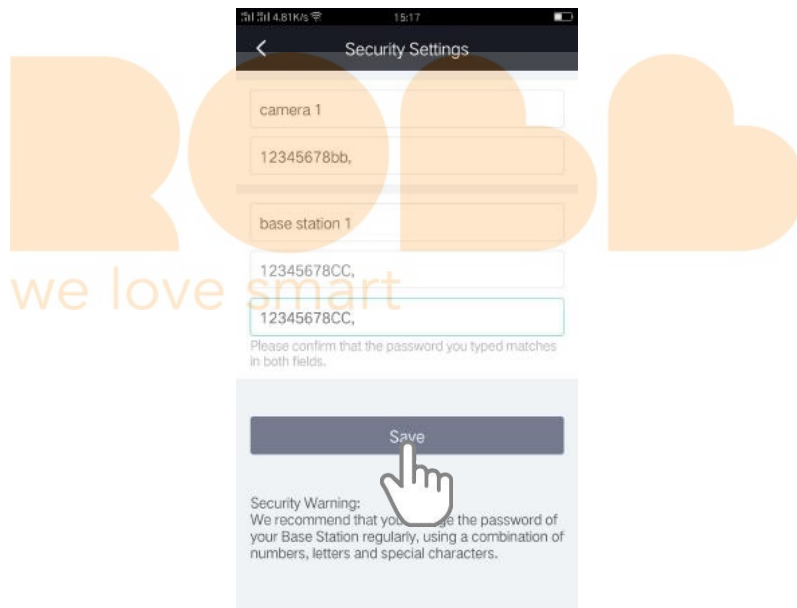

## 4.8. Upgrade Base Station Firmware

### Warning:

**We recommend that you regularly update your Base Station to the latest available firmware version to help ensure the best experience for your Base Station.**

1. Tap the **Foscam** icon  on your mobile device.



The Devices page displays.

2. Tap **Setting**  > **Firmware Upgrage** .

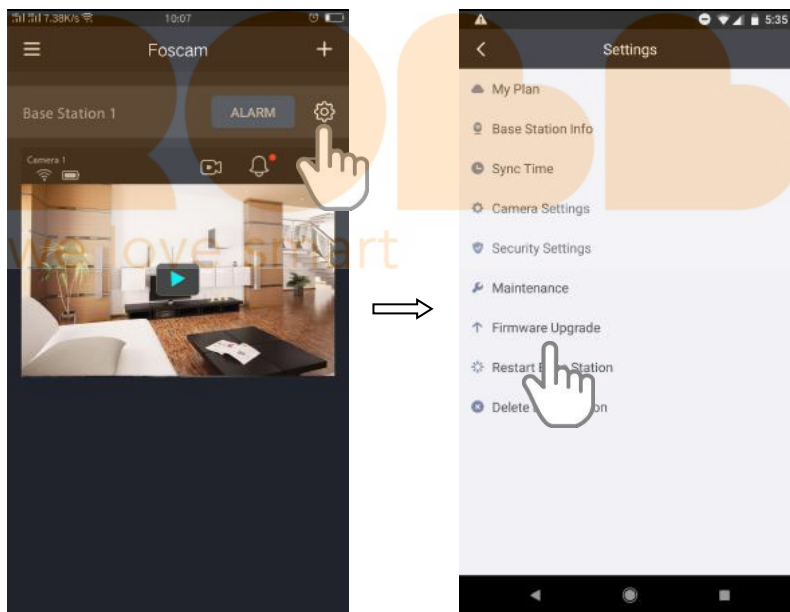

3. Tap **Upgrage** to upgrade the latest available firmware.



After a Base Station firmware update, the Base Station reboots and connects to the Internet.

**Important:**

**Please make sure the Base Station is powered on while it is updating and installing firmware.**

## 4.9. Restart Base Station

1. Tap the **Foscam** icon  on your mobile device.

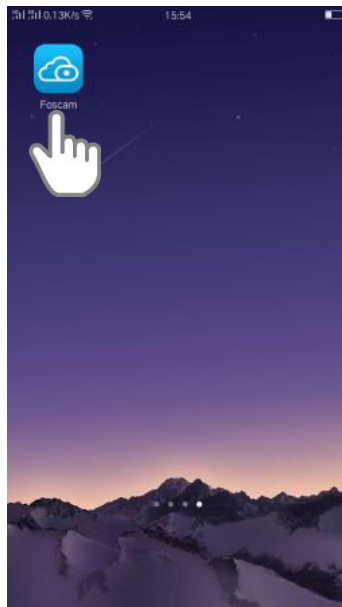

The Devices page displays.

2. Tap **Setting**  > **Restart Base Station** .

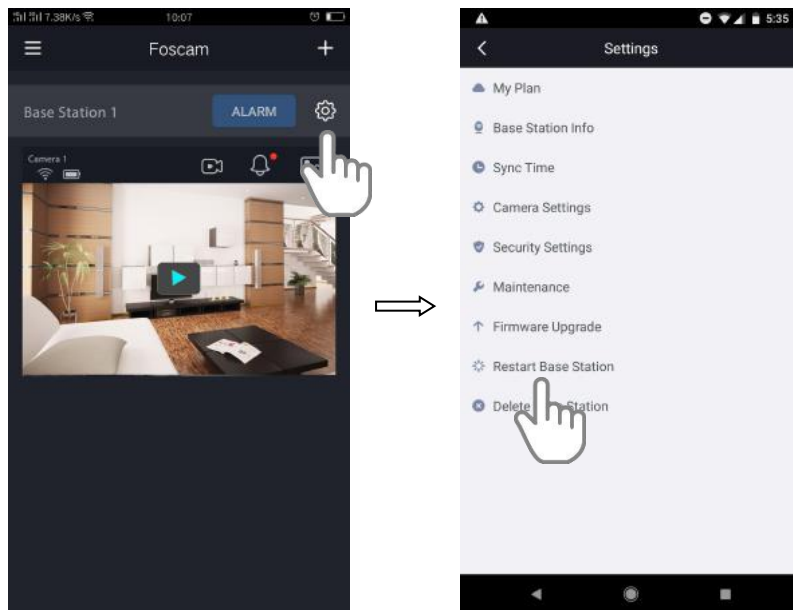

3. Tap **Restart** to restart Base Station.

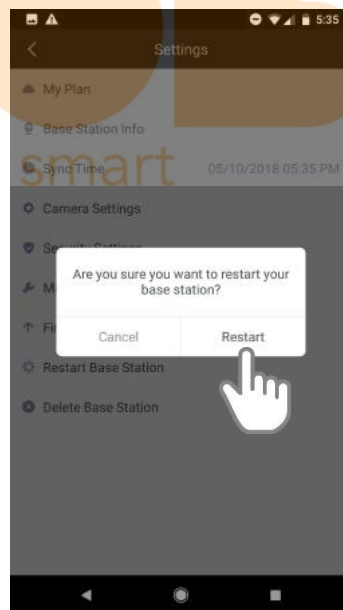

## 4.10. Delete Base Station

1. Tap the **Foscam** icon  on your mobile device.



The Devices page displays.

2. Tap **Setting**  > **Delete Base Station** .

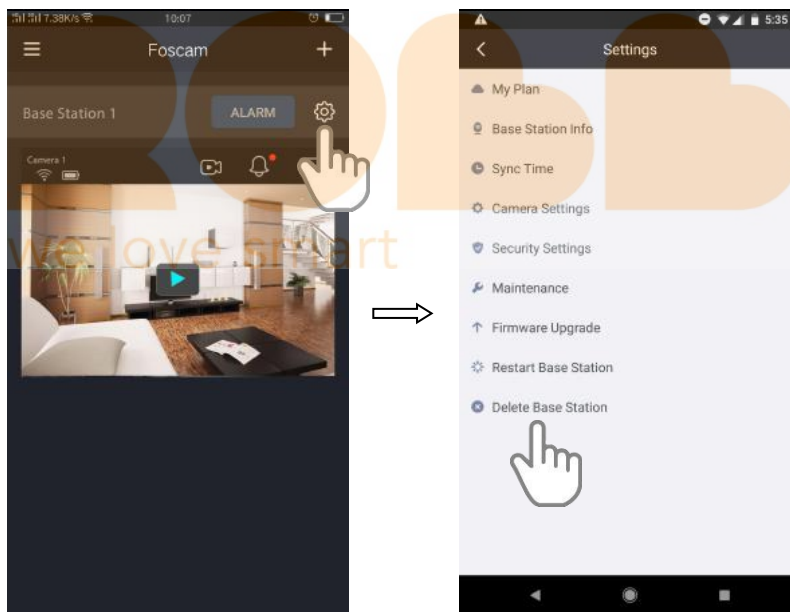

3. Tap **Yes** to delete Base Station.



## 4.11. Camera Settings

### 4.11.1 Rename Your Camera

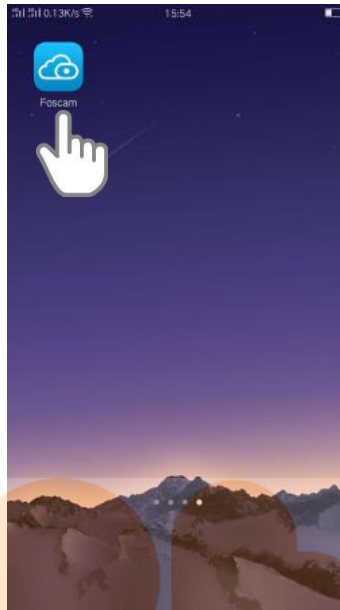
1. Tap the **Foscam** icon  on your mobile device.



The Devices page displays.

2. Tap **Setting**  > **Camera Settings**  > **Select a Camera** > **Camera Info** .

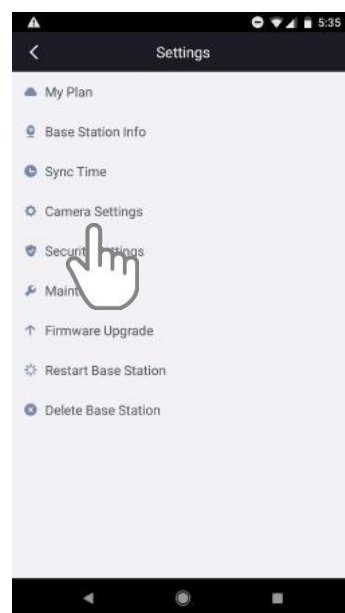
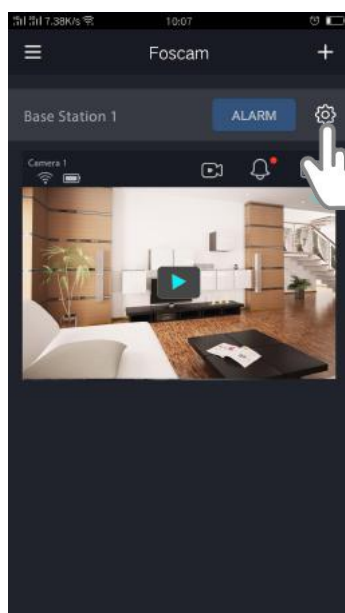

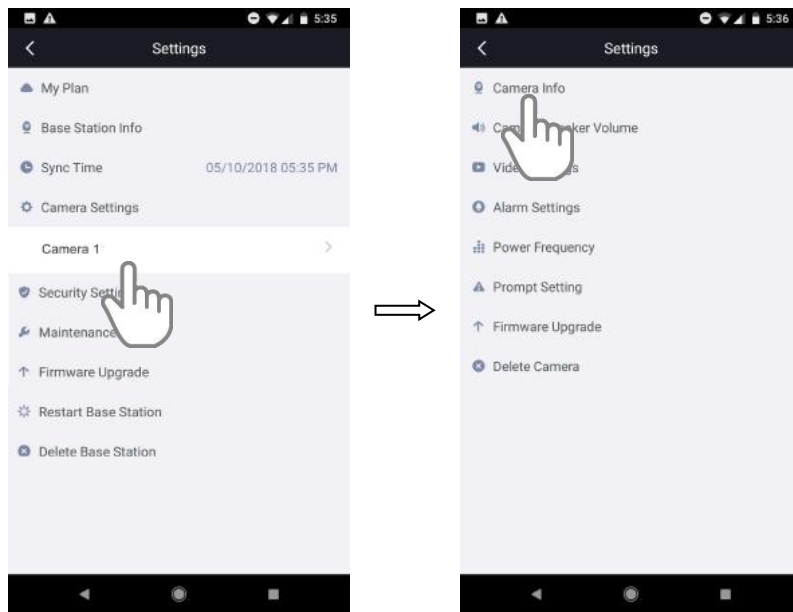

3. Enter a new name for the camera.

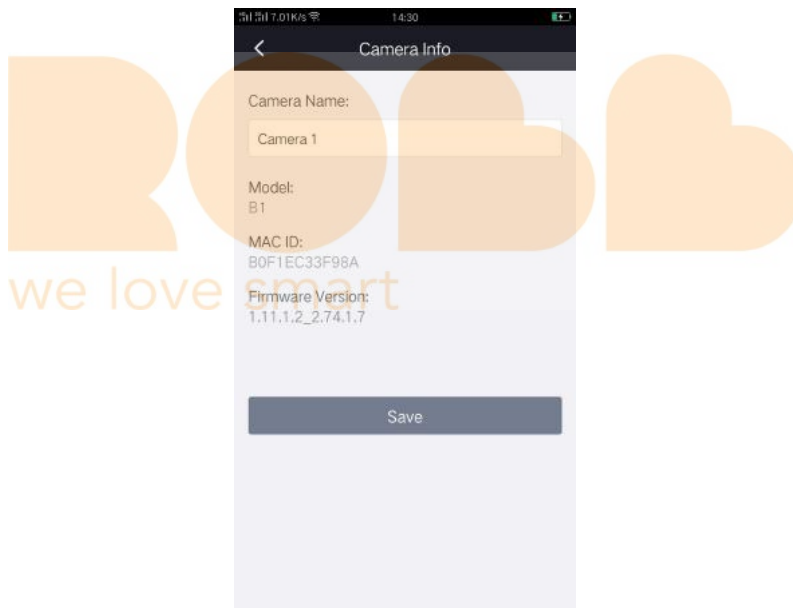

The new name will be displayed in the app.

#### 4.11.2 View Camera Information

You will view camera name, Model, MAC ID and the firmware version.

1. Tap the **Foscam** icon  on your mobile device.

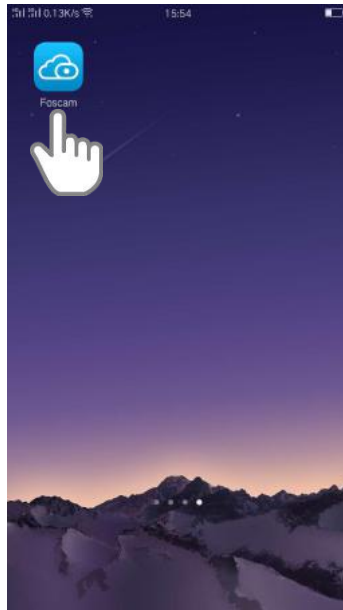

The Devices page displays.

2. Tap **Setting**  > **Camera Settings**  > **Select a Camera** > **Camera Info**  .

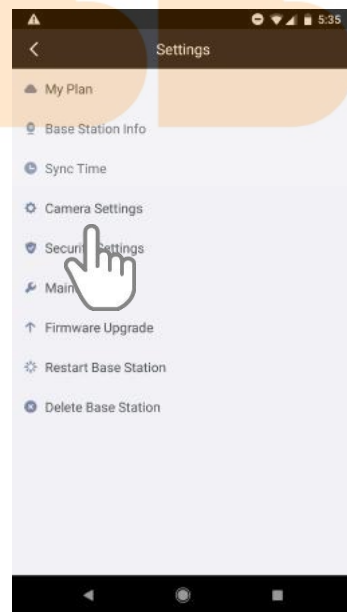
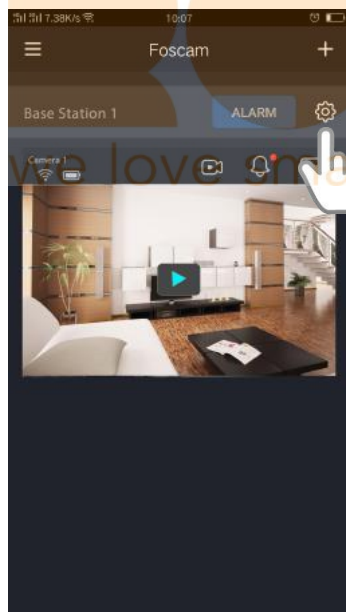



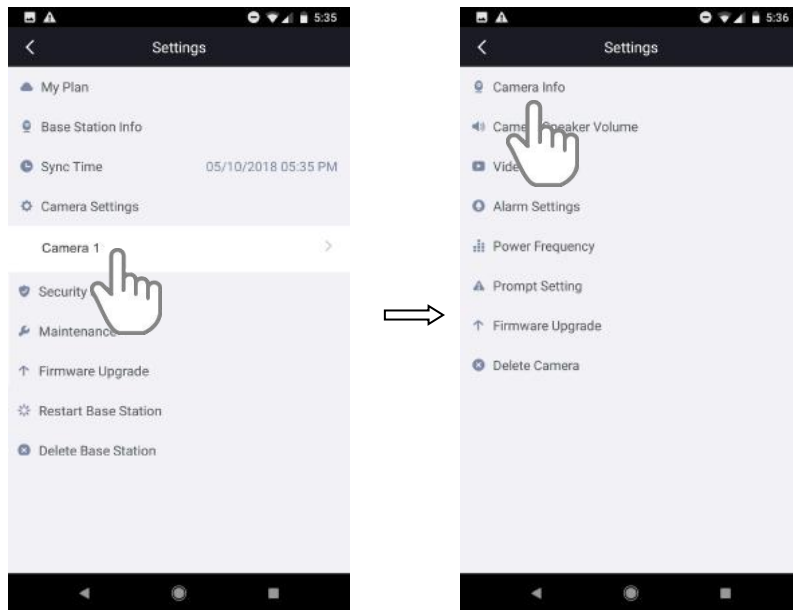

3. You will view camera name, Model, MAC ID and the firmware version.

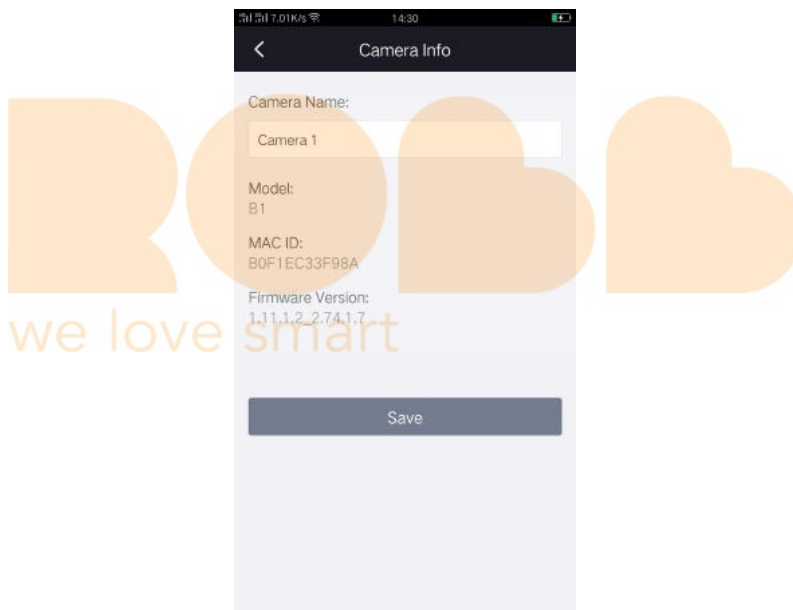

### 4.11.3 Change Speaker Volume

You can control the volume on your camera settings.

1. Tap the **Foscam** icon  on your mobile device.

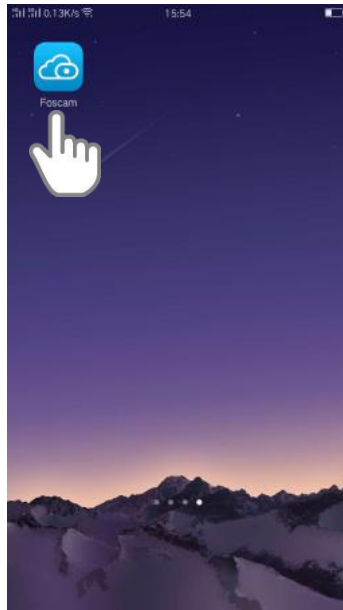

The Devices page displays.

2. Tap **Setting**  > **Camera Settings**  > **Select a Camera** > **Camera**

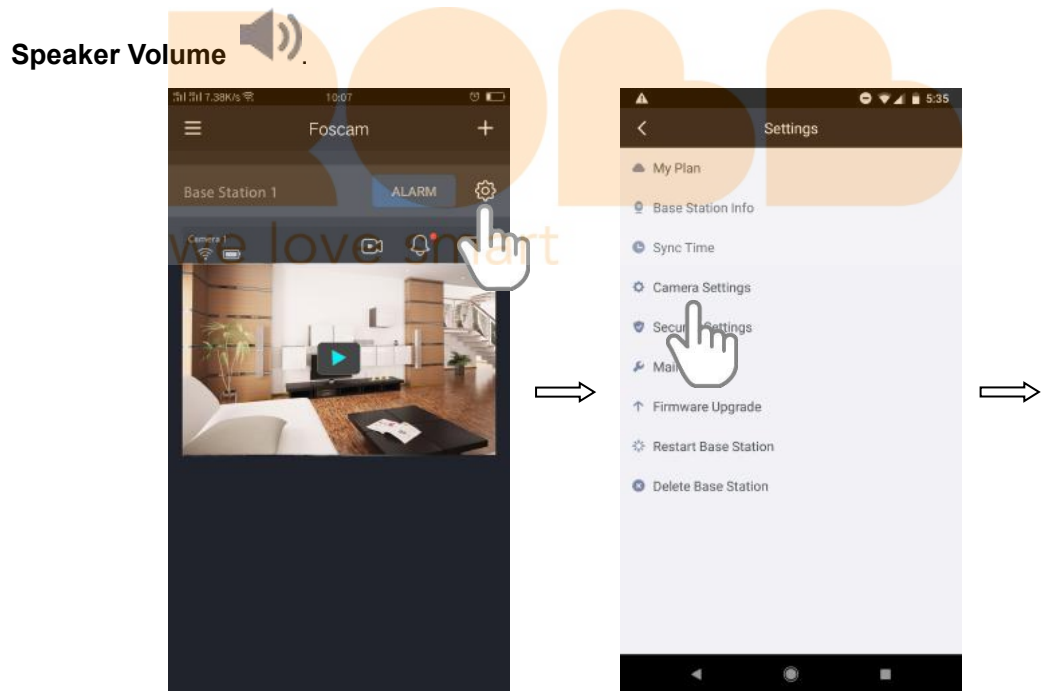

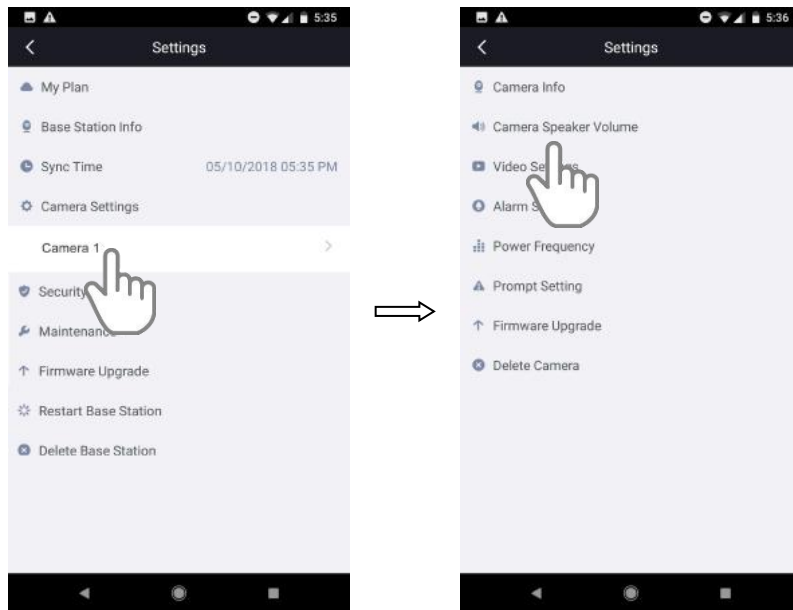

3. To change the speaker volume, move the **Speaker Volume** slider.

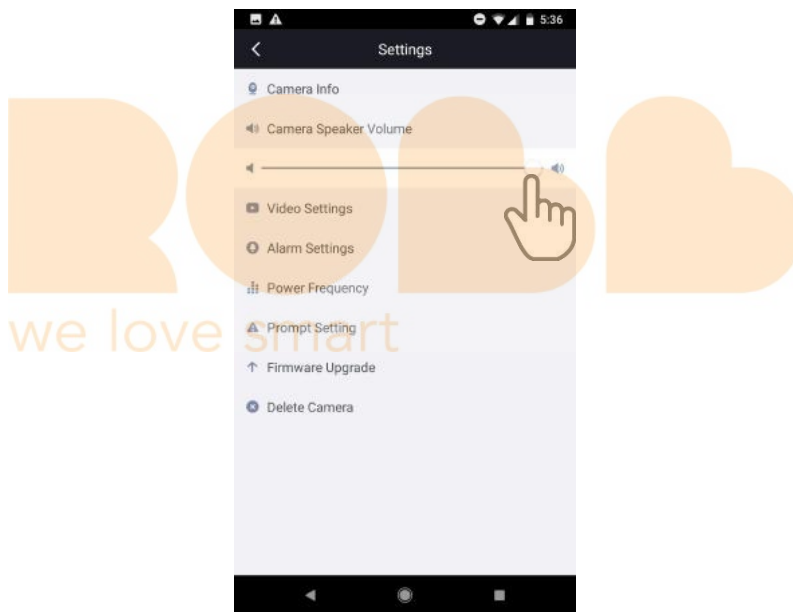

Your settings are saved.

#### 4.11.4 Change Video Quality

There are three options for you to choose. Decreasing the resolution of videos reduces the required WiFi bandwidth and battery life.

1. Tap the **Foscam** icon  on your mobile device.

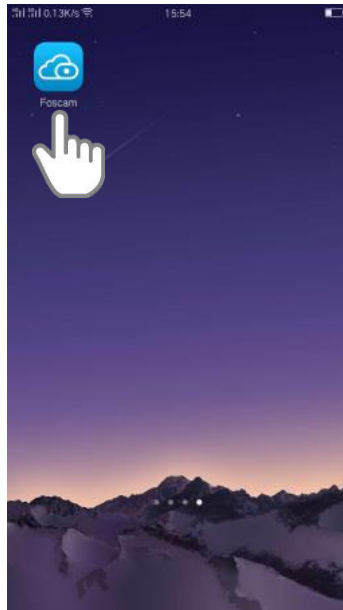

The Devices page displays.

2. Tap **Setting**  > **Camera Settings**  > **Select a Camera** > **Video**

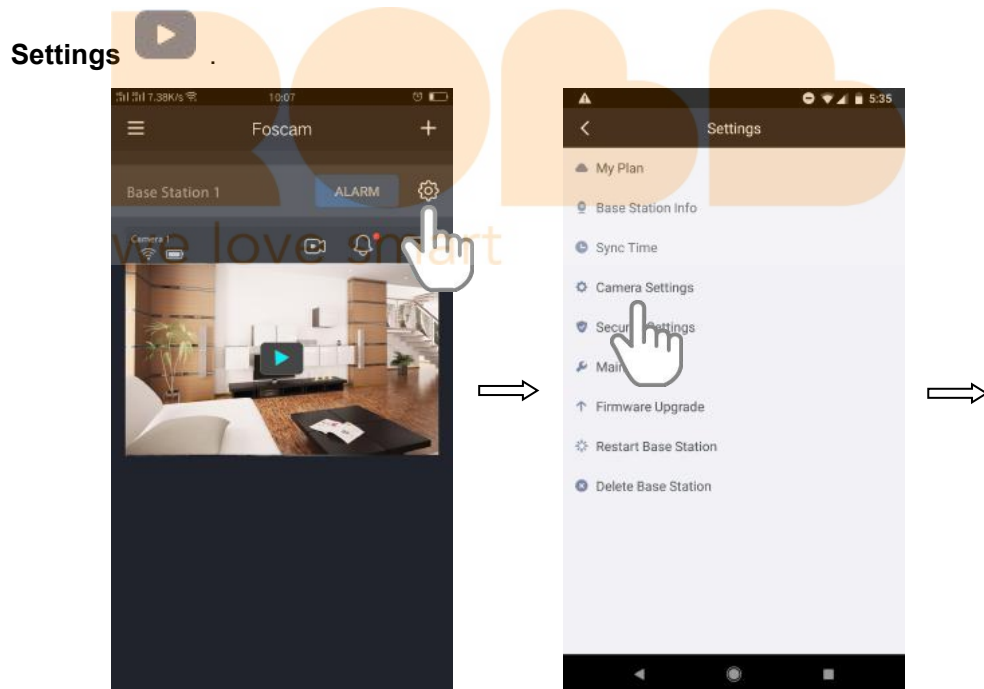

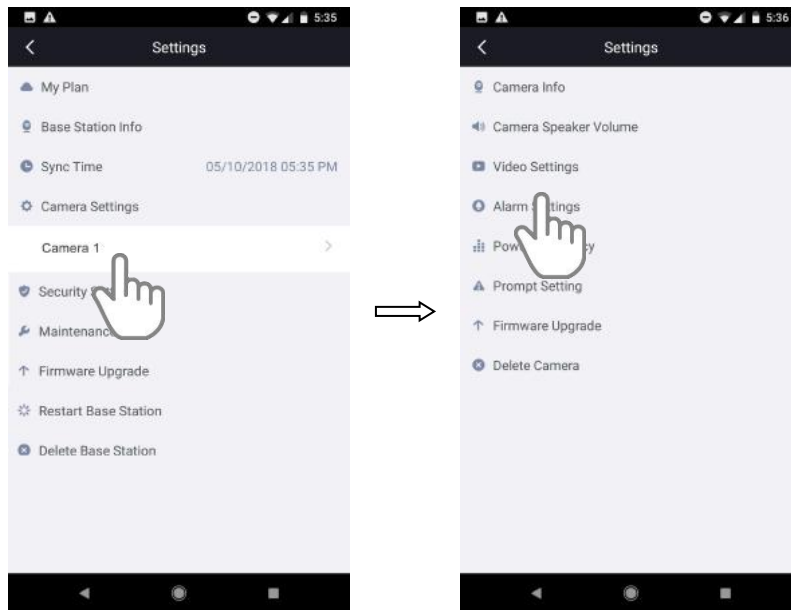

3. Tap **Image Quality**, choose a setting.

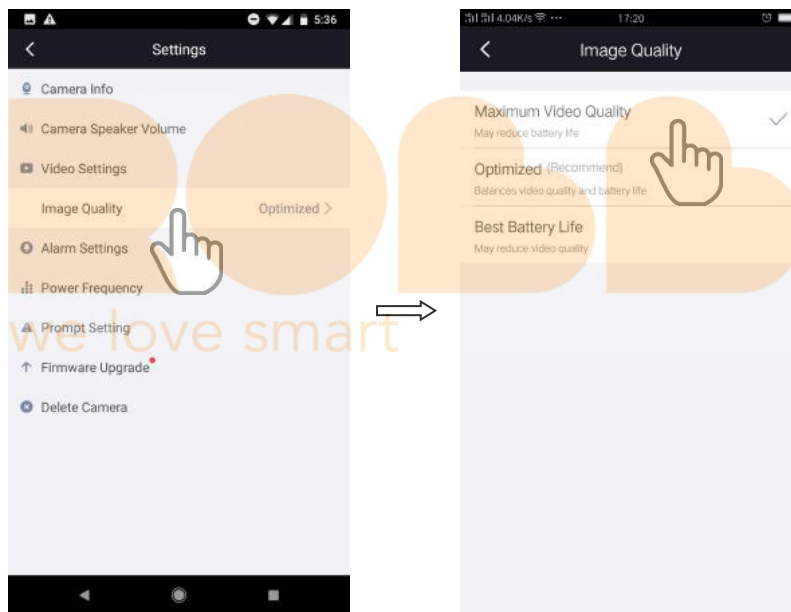

Your settings are saved.

## 4.11.5 Adjust the Power Frequency

If the camera video is flashing, please try to adjust the power frequency.

1. Tap the **Foscam** icon  on your mobile device.

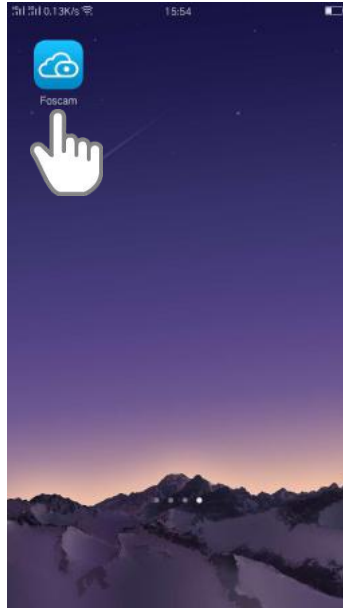

The Devices page displays.

2. Tap **Setting**  > **Camera Settings**  > **Select a Camera** > **Power**

Frequency .

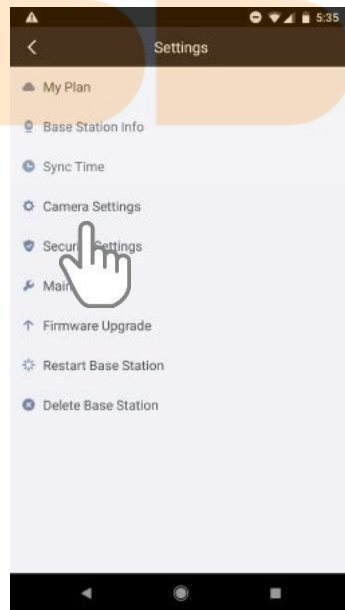
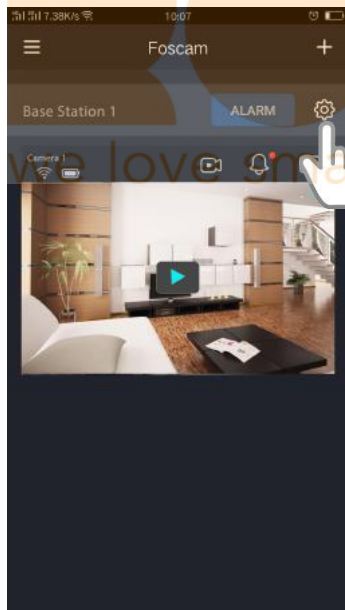

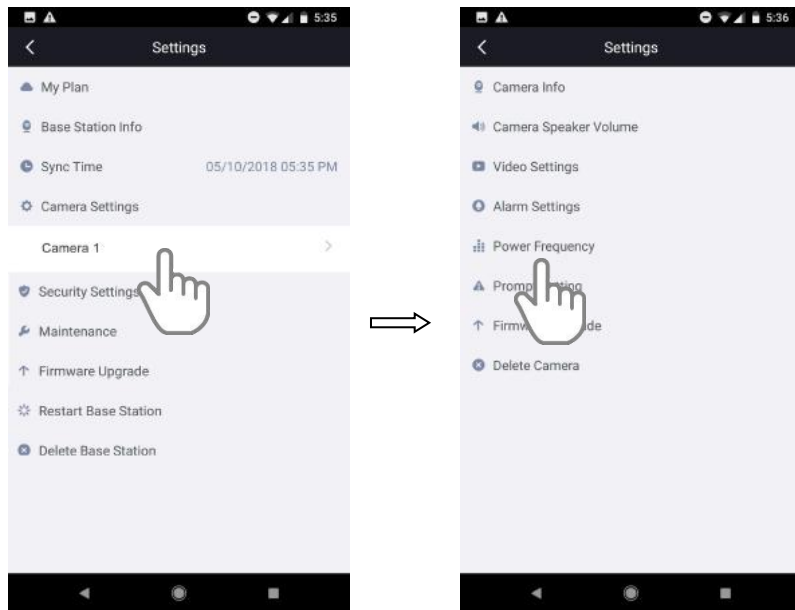

3. Tap a setting.

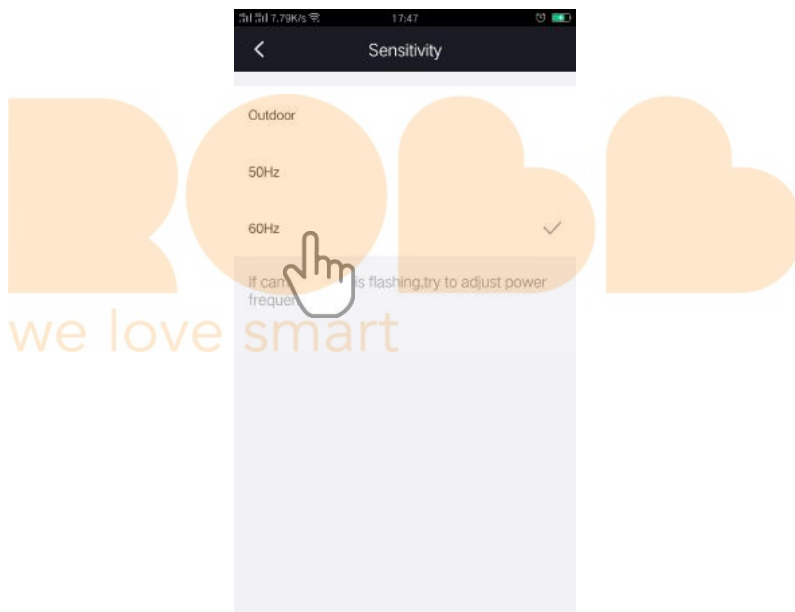

Your settings are saved.

### 4.11.6 Turn On / Off the Camera LED

The LED on the camera lights in different colors. You can turn off this LED.

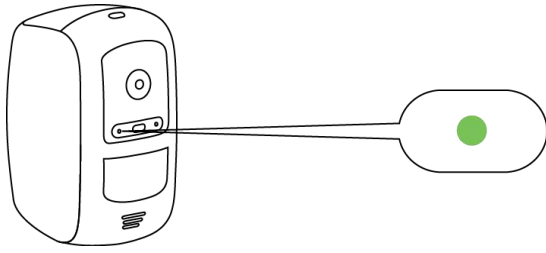

1. Tap the **Foscam** icon  on your mobile device.

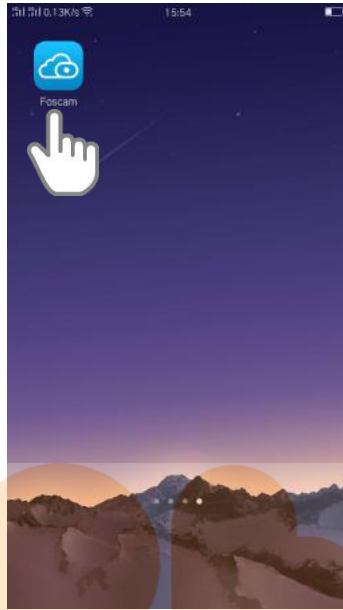

The Devices page displays.

2. Tap **Setting**  > **Camera Settings**  > **Select a Camera** > **Prompt Setting**





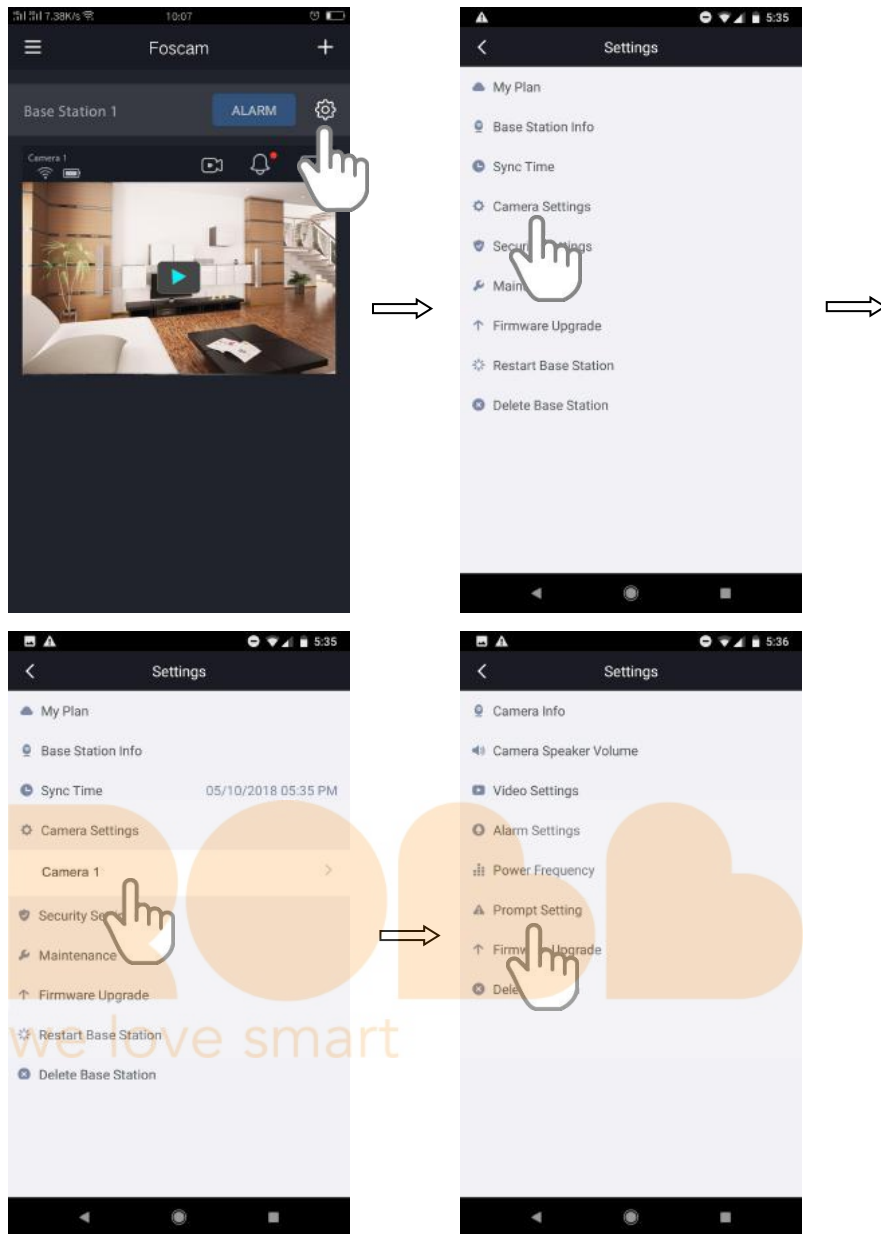

3. Tap the button on the right side of **Status LED** to turn on / off the camera LED. Your settings are saved.

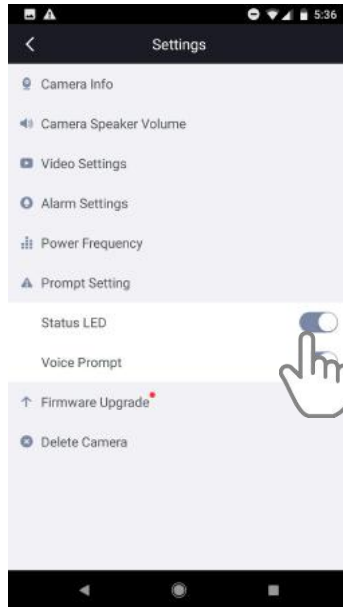

### 4.11.7 Turn On / Off the Voice Prompt

The voice prompt is ON by default. You can turn off the voice prompt.

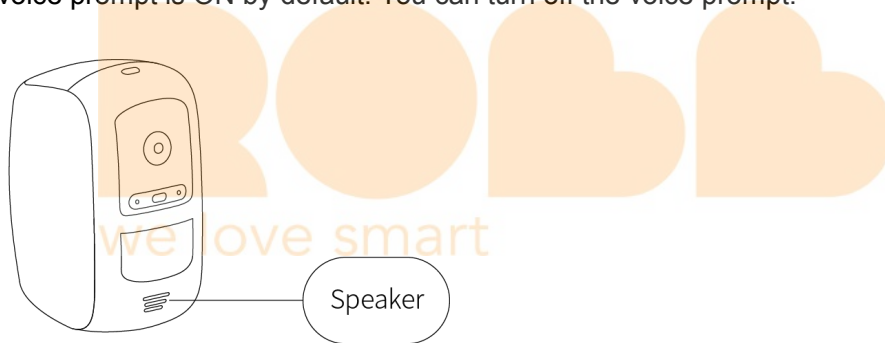

1. Tap the **Foscam** icon  on your mobile device.

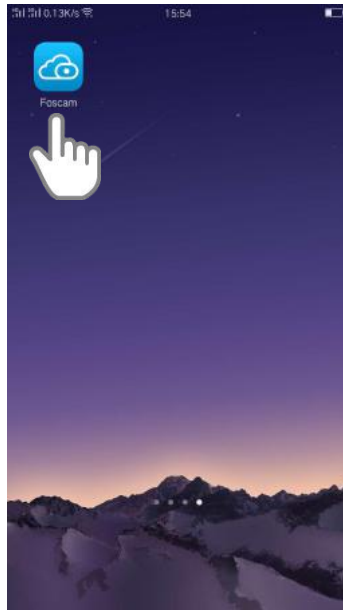

The Devices page displays.

2. Tap **Setting**  > **Camera Settings**  > **Select a Camera** > **Prompt Setting**

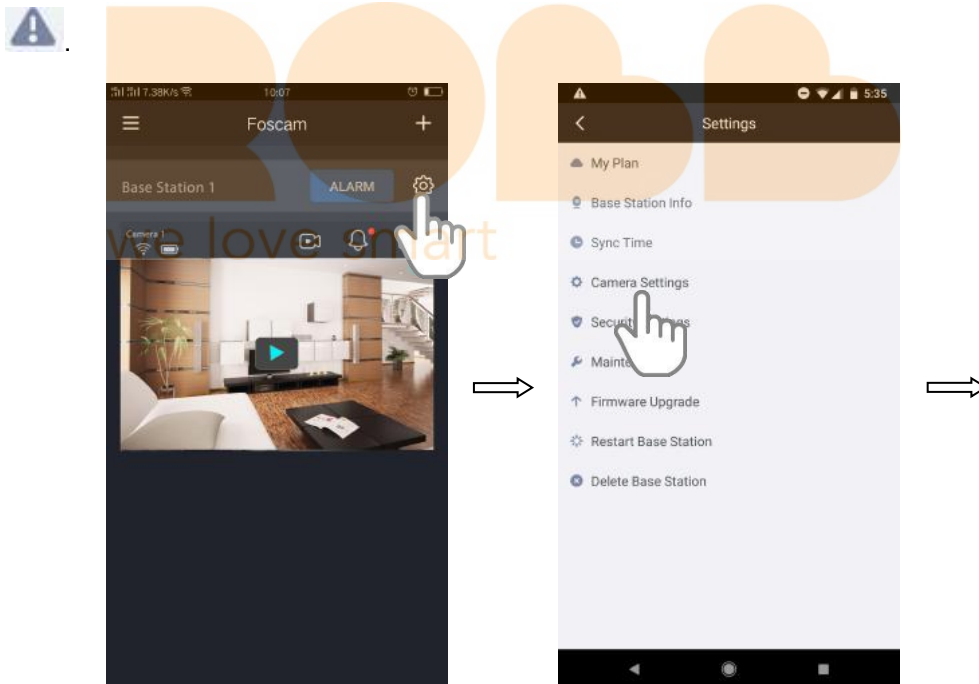

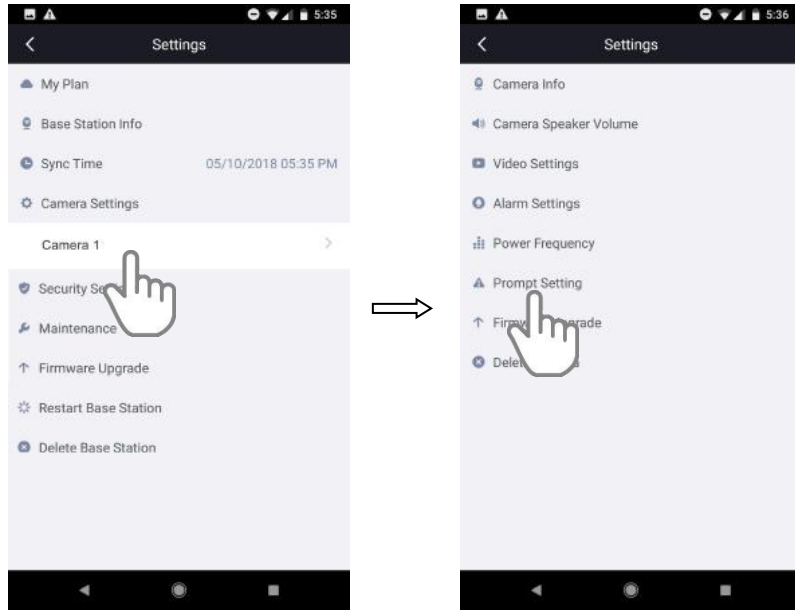

3. Tap the button on the right side of **Voice Prompt** to turn on / off the voice prompt. Your settings are saved.

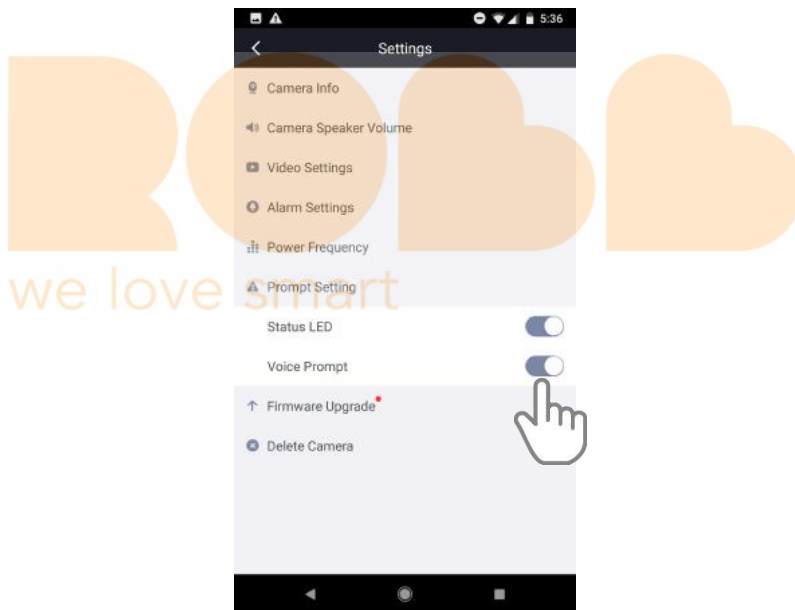

## 4.11.8 Upgrade Camera Firmware

### Warning:

We recommend that you regularly update your camera to the latest available firmware version to help ensure the best experience for your camera.

1. Tap the **Foscam** icon  on your mobile device.

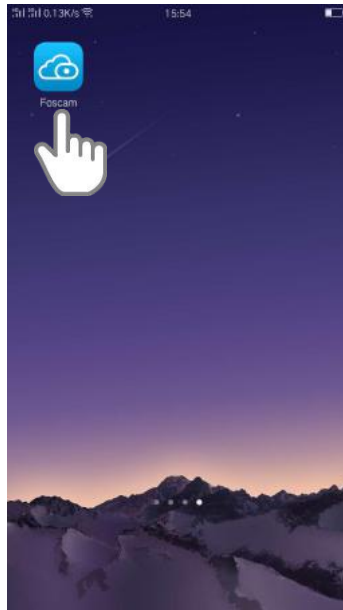

The Devices page displays.

2. Tap **Setting**  > **Camera Settings**  > **Select a Camera** > **Firmware**

**Upgrade** 

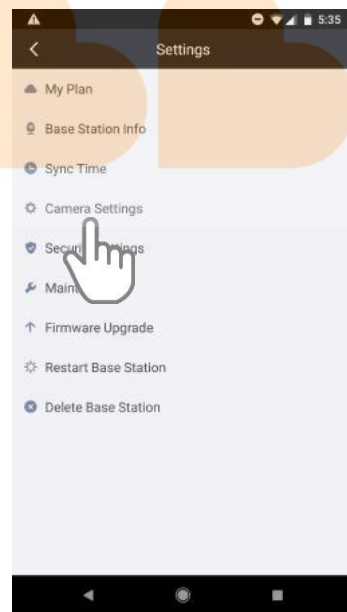
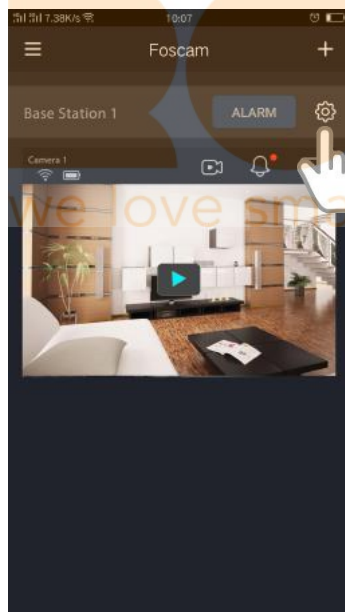

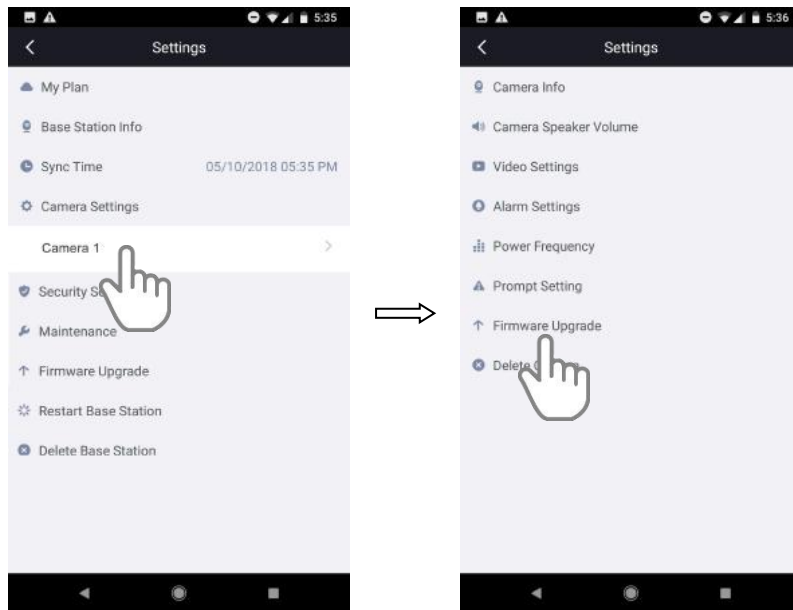

It will upgrade the firmware automatically if the firmware of camera is not the latest.

**Important:**

Please make sure the camera and Base Station are powered on, and do not move them while it is updating and installing firmware. After the camera firmware update completes, the camera syncs to the Base Station again and the camera LED blinks green rapidly for 10 seconds.

### 4.11.9 Delete a Camera

1. Tap the **Foscam** icon  on your mobile device.

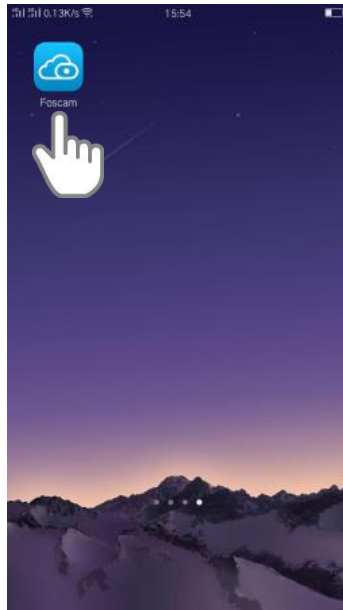

The Devices page displays.

2. Tap **Setting**  > **Camera Settings**  > **Select a Camera** > **Delete**

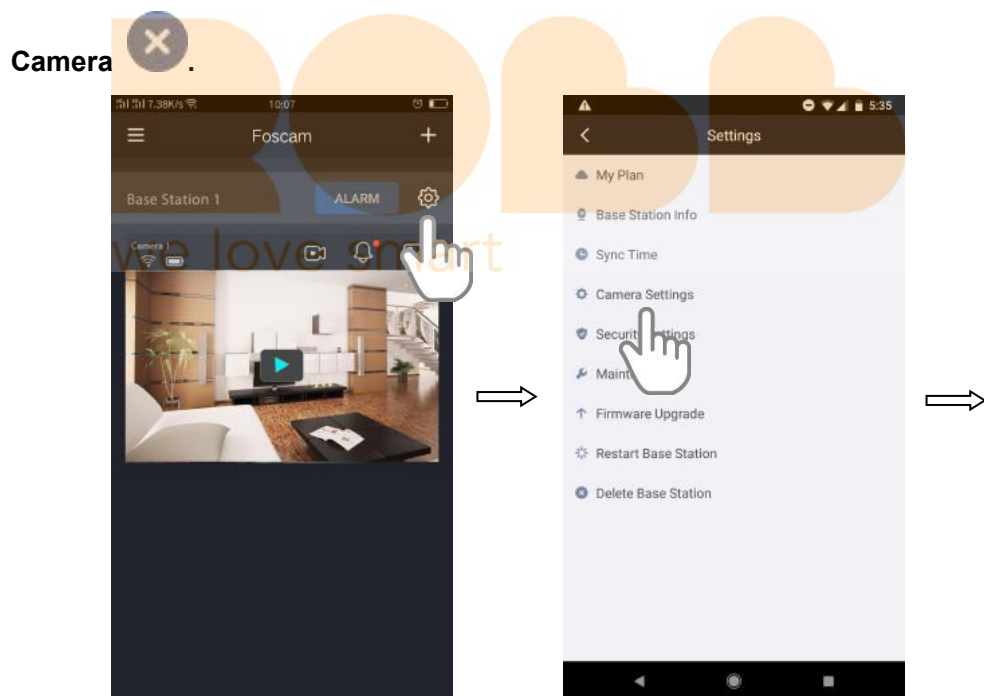

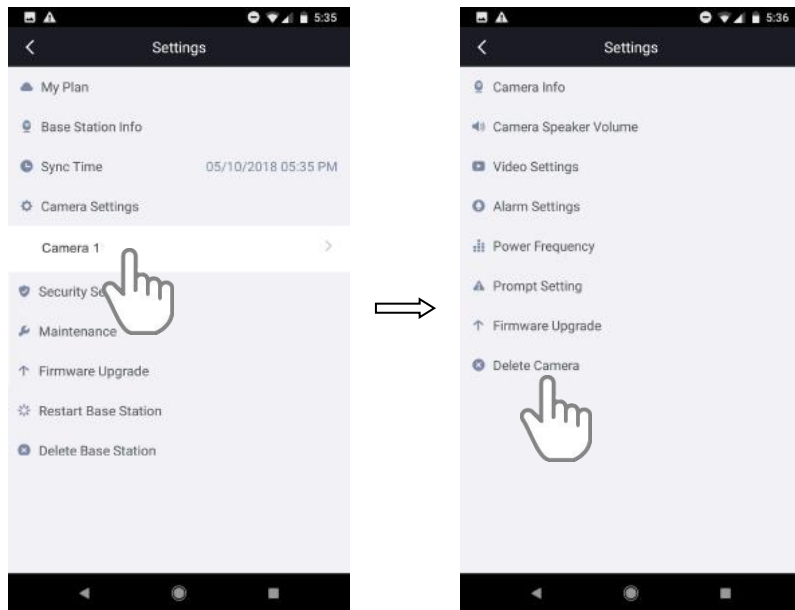

3. Selecting **Delete the history files of the camera** to delete the history files.

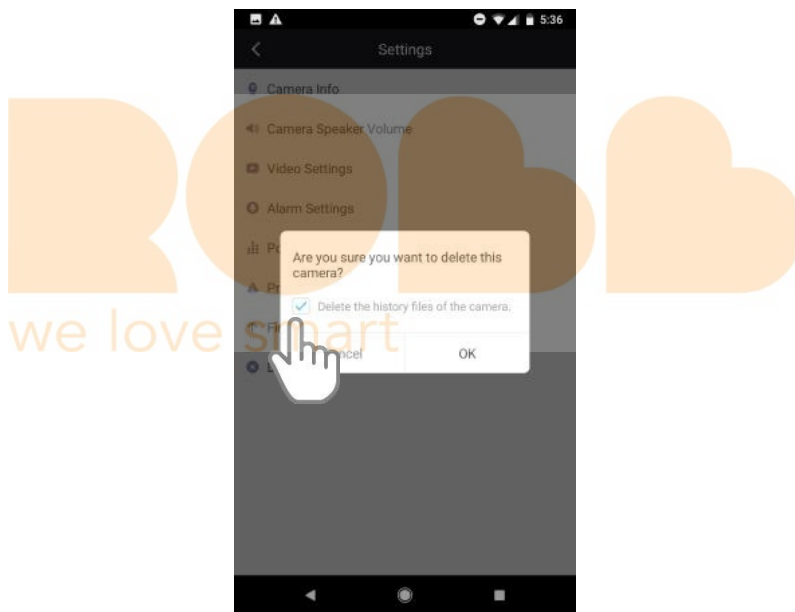



4. Tap **OK** to delete the camera.

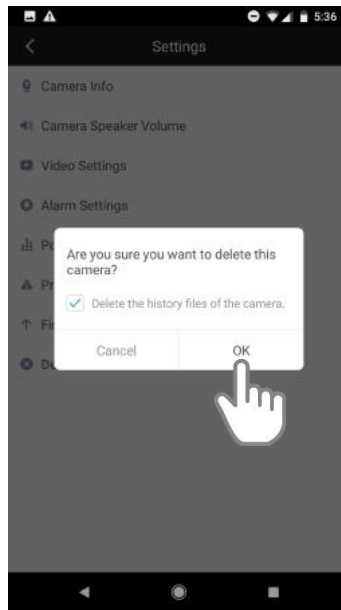

## 4.12. Forgotten Base Station User Name & Password?

To reset the Base Station user name and password, you had better unplug the network cable firstly. After that, press and hold down the **RESET BUTTON** about 5 seconds. Releasing the reset button, the password will turn to the factory default.

Default administrator username / password: **admin with blank password**

# 5. App Settings

## 5.1. View the Live Video Only In WiFi Environment

1. Tap the **Foscam** icon  on your mobile device.

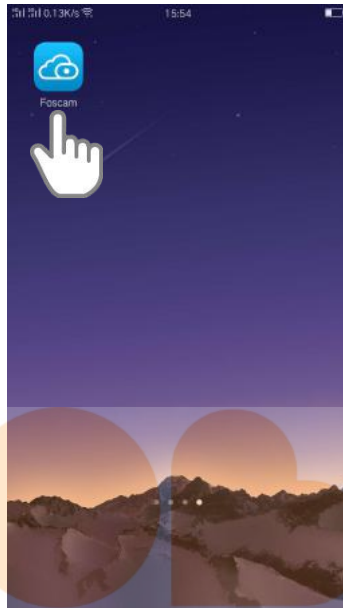

The Devices page displays.

1. Tap **Sidebar**  > **(App) Settings** .

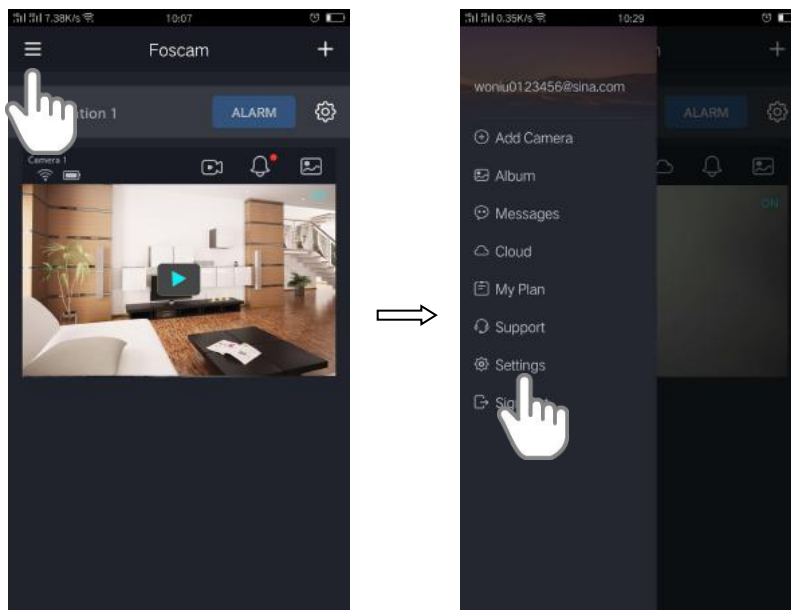

2. Tap the **WiFi Only for Streaming**  On/Off button to enable the setting.

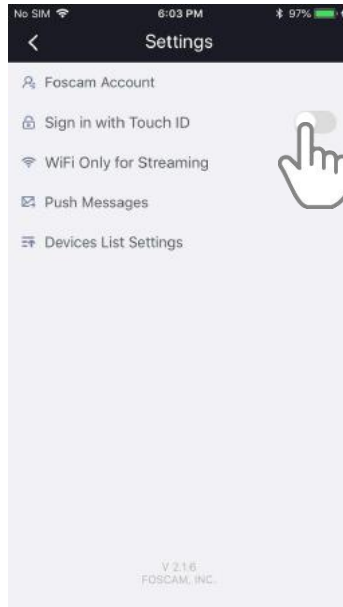

## 5.2. Push Messages

When a trigger is detected, App can send you messages if the **Push Messages** of the Base Station is **ON**.

1. Tap **Sidebar**  > **(App) Settings**  .

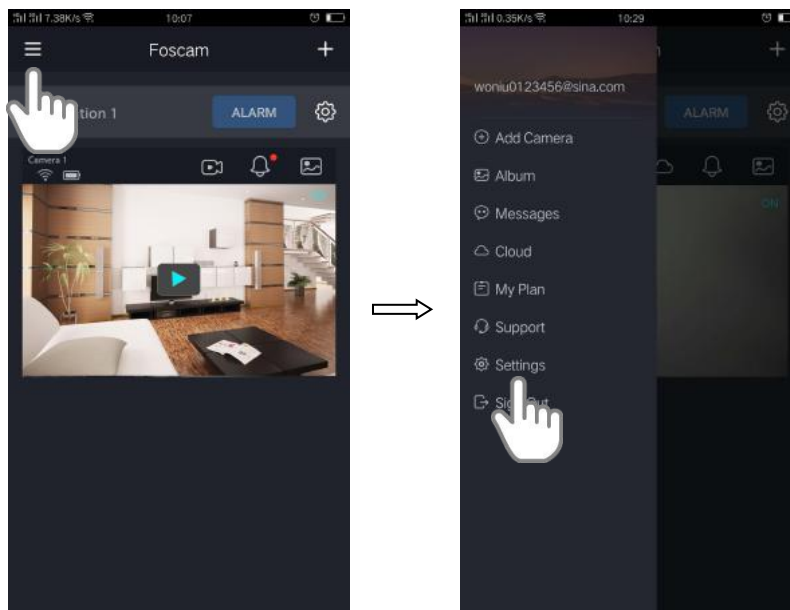

2. Tap **Push Messages** , turn **On** button to set push messages function on Base Station 1.

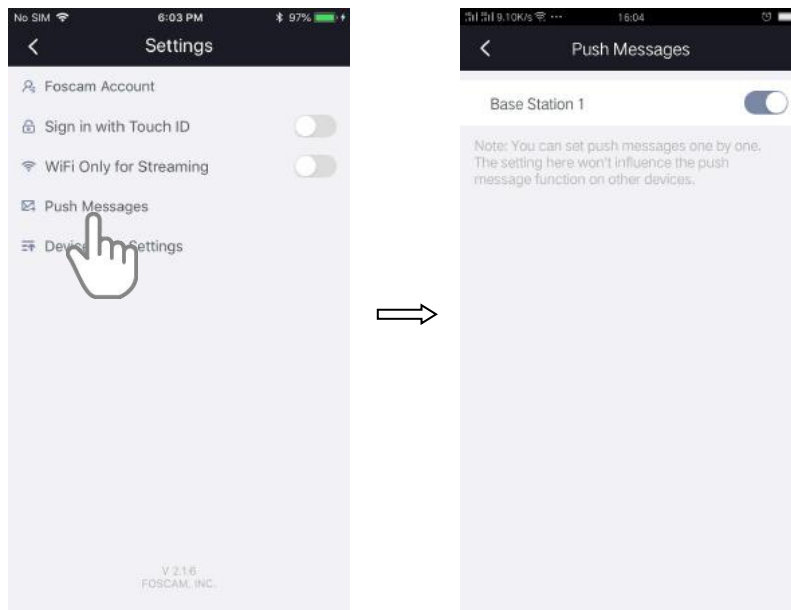

### 5.3. Devices List Settings

1. Tap the **Foscam** icon  on your mobile device.

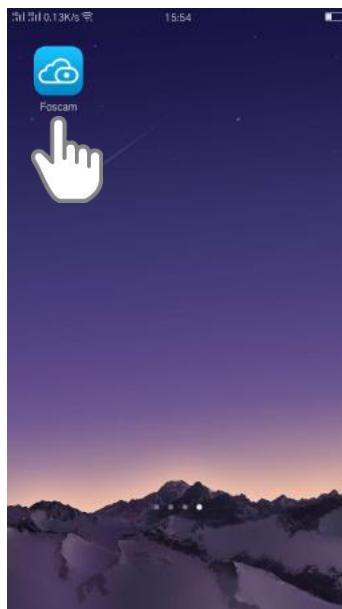

The Devices page displays.

2. Tap **Sidebar**  > **(App) Settings**  > **Devices List Settings** .

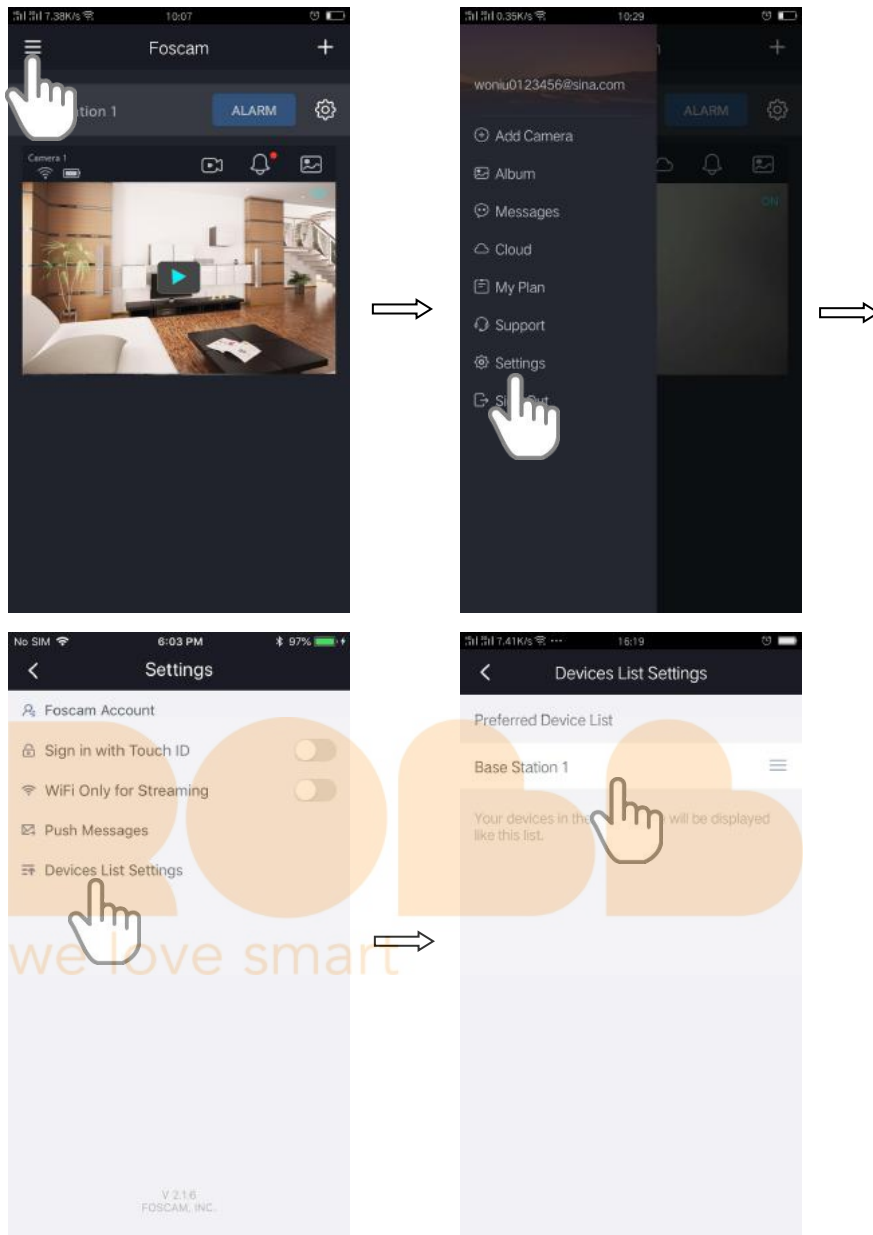

3. Hold and drag a Base Station to the correct position on the list.  
Your settings are saved.

## 5.4. Sign Out

1. Tap the **Foscam** icon  on your mobile device.

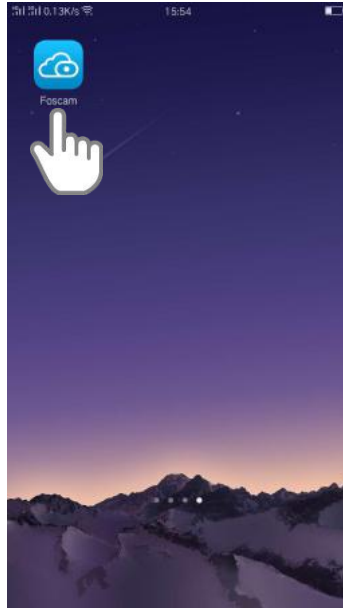

The Devices page displays.

2. Tap **Sidebar**  > **Sign Out** .

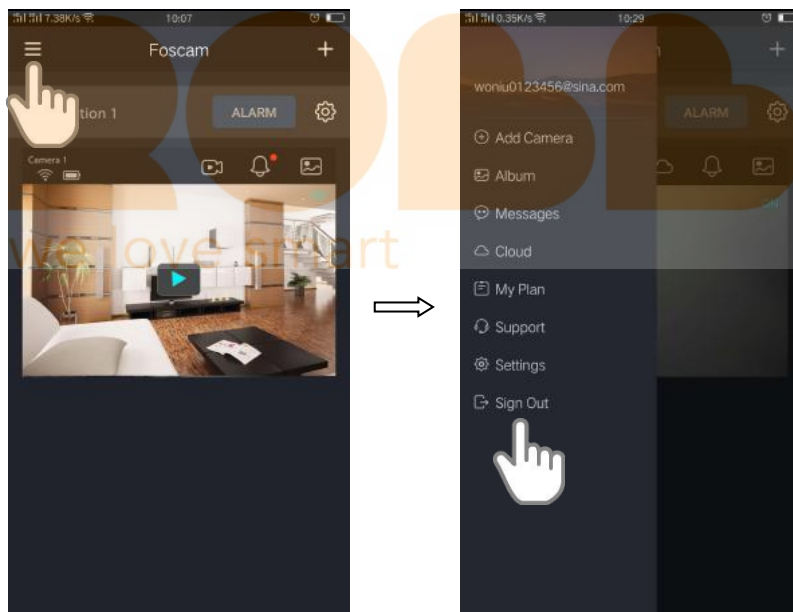

3. Tap the **Yes** to sign out the app.

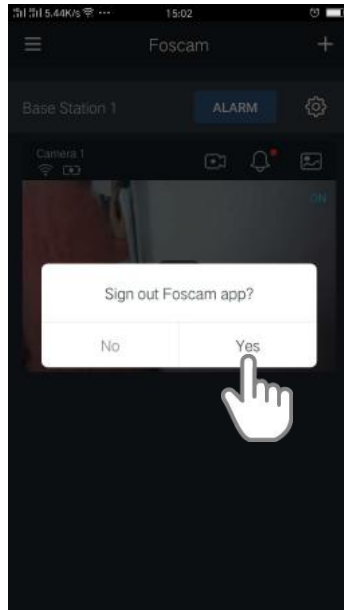

ROBB

we love smart

# 6. Appendix

## 6.1. CE & FCC

### Electromagnetic Compatibility (EMC)

#### FCC Statement



This device complies with FCC Rules PART 15C of the FCC Rules. Operation is subject to the following two conditions.

- This device may not cause harmful interference, and This device must accept any interference received, including interference that may cause undesired operation.

This equipment has been tested and found to comply with the limits for a Class A digital device, pursuant to Part 15 of the FCC Rules. These limits are designed to provide reasonable protection against harmful interference when the equipment is operated in a commercial environment. This equipment generates, uses, and can radiate radio frequency energy and, if not installed and used in accordance with the installation manual, may cause harmful interference to radio communications. Operation of this equipment in a residential area is like to cause harmful interference, in which case the user will be required to correct the interference at his own expense.

#### FCC Caution

Any changes or modification not expressly approved by the party responsible for compliance could void the user's authority to operate this equipment.

This equipment complies with FCC radiation exposure limits set forth for an uncontrolled environment.

This equipment should be installed and operated with minimum distance 20cm (7.9in) between the radiator& your body.

This transmitter must not be co-located or operating in conjunction with any other antenna or transmitter.

#### CE Mark Warning





This is a Class B product. In a domestic environment, this product may cause radio interference, in which case the user may be required to take adequate measures.

## 6.2. WARRANTY

FOSCAM values your business and always attempts to provide you the very best of service.

No limited hardware warranty is provided by FOSCAM unless your FOSCAM product ("product") was purchased from an authorized distributor or authorized reseller.

Distributors may sell products to resellers who then sell products to end users. No warranty service is provided unless the product is returned to an authorized return center in the region where the product was first shipped by FOSCAM or to the point-of-purchase, which may have regional specific warranty implications.

**If you purchase your FOSCAM product from online store, please contact the point-of-purchase and ask for return / replacement / repair service.**

### Limited Hardware Warranty

FOSCAM products are warranted to be free from manufacturing defects in materials and workmanship starting from the shipping date of FOSCAM.

This limited hardware warranty does not cover:

- Software, including the software added to the products through our factory-integration system, software, etc.
- Usage that is not in accordance with product instructions.
- Failure to follow the product instructions.
- Abuse firmware upgrade without the authorized technician's guidance.
- Normal wear and tear.

### Return Procedures

- Please read FOSCAM warranty policy & policy of your reseller first before sending items back to point-of-purchase.
- Customer must first contact point-of-purchase to obtain a Return Merchandise Authorization (RMA) number before returning the product. If the product you received is suspected to be defective and the product warranty has not expired, The RMA number will allow your reseller to track your return much easier and help them expedite processing your request.
- After receiving your RMA case number, pack the item(s) very well with the original box and all the original accessories included such as power adapters, brackets, cables, manuals.

- Write your RMA number and the return reason (the problem of the product) on the warranty card along with the complete package to send them back.

### **Replacement Services**

- **If customers ask for replacement service, please contact point-of-purchase and follow their policy.**
- Our technicians will inspect all items returned for replacement requests. If the returned product is found in working order, we will return the same item received. However customers shall be responsible for all shipping & handling charges incurred for getting the units back to customers.
- If returned products are found defective, we will replace the product and assume the shipping cost for sending back the replacement unit to customers.
- If for any reason, we are unable to provide a replacement of the original returned item(s). You will have a choice for a "Substitute" item at the same equal value.
- We do not provide exchange and replacement due to normal hardware upgrade according the market after 14 days after the product is delivered.
- Our technicians will test the product before send out the replacement, any other demand for more than two times replacement for the same product during replacement limit will be rejected.
- **Replaced products are warranted from the balance of the former warranty period.**

### **Warranty Forfeiture**

- Warranty is void if purchase from unauthorized distributor or reseller.
- **Warranty is void if trade-mark, serial tags, product stickers have been removed, altered or tampered with.**
- Warranty is void for mishandling, improper use, or defacing the product.
- **Abuse firmware upgrade without the authorized technician's guidance.**
- Warranty is void for physical damage, altered, either internally or externally, improper or inadequate packaging when returned for RMA purposes.
- Warranty is void if damage has resulted from accident, dismantle, abuse, or service or modification by someone other than the appointed vendor, source, fission or the spare part has been over the period of warranty.
- Warranty is void if product is damaged due to improper working environment or operation. (For example, improper temperature, humidity, unusual physical or electrical stress or interference, failure or fluctuation of electrical power, static electricity, using wrong power adapter, etc.)
- Warranty is void if damaged by the use of parts not manufactured or sold by FOSCAM.
- Damage caused by improper installation of third-party products.
- Warranty is void if damaged for irresistible cause, such as earthquake, fire, lightning, flood, etc.
- Product beyond limited warranty.

### **Shipping Fee**

- If products are defective or damaged under normal use or operation in the replacement limit, distributors or resellers are responsible for the shipping cost the product back to customers, customers should assume the shipping cost send the product to the point-of-purchase.
- During replacement limit, if customers ask for replacement due to the product does not fit for customer's personal expectation, customers should responsible for both shipping fee.
- Customers shall be responsible for both shipping fee if their product beyond the replacement limit but still in warranty limit.

### **Repair Service Out Of Warranty**

- FOSCAM provide extra repair service for product that out of warranty, it is chargeable. The total fee contains device cost and service fee. Device cost (including accessories) is the standard uniform price provide by FOSCAM.
- Different region may have different service fee, please contact the point-of-purchase to confirm that before you ask for this service.
- Our technicians will quote the total price after detect the product, If customers refused to repair after the quotation, customers need pay for the test fee, \$3.5 / hour. If agree with the quotation, test will be free.
- Repaired product out of warranty will obtains 3-month warranty from the date of the product back to customers.

### **Limitation of Liability**

- FOSCAM is not responsible for other extra warranty or commitment promised by resellers, if your reseller promised some extra commitment or warranty; please ask for written documents to protect your rights and interests.
- FOSCAM does not offer refunds under any circumstances. Please contact the point-of-purchase and follow their refund / return policy.
- FOSCAM shall not be liable under any circumstances for any consequential, incidental, special or exemplary damages arising out of or in any connection with this agreement or the products, including but not limited to lost profits, or any claim based on indemnity or contribution, or the failure of any limited or exclusive remedy to achieve its essential purpose or otherwise. Purchaser's exclusive remedy, as against FOSCAM, shall be the repair or replacement of defective parts. If FOSCAM lists a product on its website specification in error or that is no longer available for any reason, FOSCAM reserves the right to explain it without incurring any liability.

**All rights reserved. FOSCAM and the FOSCAM logo are trademarks of ShenZhen FOSCAM Intelligent Technology Limited., registered in the U.S. and other countries.**

## 6.3. Statement

We advise that you take steps to safeguard your privacy. This includes keeping personal account information private, changing your account and equipment password periodically, and upgrading firmware whenever updates are available.

Our company makes no warranty, implied or otherwise, that this product is suitable for any particular purpose or use. You need to abide by the relevant laws and regulations of the use restrictions when using Foscam cameras. Our company takes no responsibility of illegal activities by using our products.

Our company takes no responsibility of the loss by force majeure, such as failure or faults of telecom system or the Internet network, computer viruses, malicious attacks of hackers, information damage or loss, and faults of computer system.

Foscam company does not need to take any responsibility of the special, incidental or corresponding loss by the products of our company or any software provide by our company, including but not limited to operating loss, profit or purpose. The company only takes the responsibility applicable to national and local legal requirements.

Our company takes no responsibility of the loss caused by the following at any time:

- 1) loss of purchases;
- 2) loss of intangible property damage, such as data, programs;
- 3) loss of compensation claimed by third-party customers.

Delete images, format the memory card or other data storage devices does not completely remove the original image data. You can restore deleted files from discarded the storage device by commercial software, but which will potentially lead to personal image data used maliciously by others. The privacy of the data security belongs to user responsibility, the company takes no responsibility.

Parts mentioned in this statement should not be understood by the configuration description of the product purchased by the customer, the product configuration must accord to the specific models purchased by the customer.

Without the prior written permission of Foscam company, all the contents of relevant operating instructions manual affiliated to the product must not be reproduced, transmitted, transcribed or stored in a retrieval system, or translated into other languages.

Our company will reserve the right to improve and modify the product and corresponding manuals. The company reserves the right of final interpretation on our products.

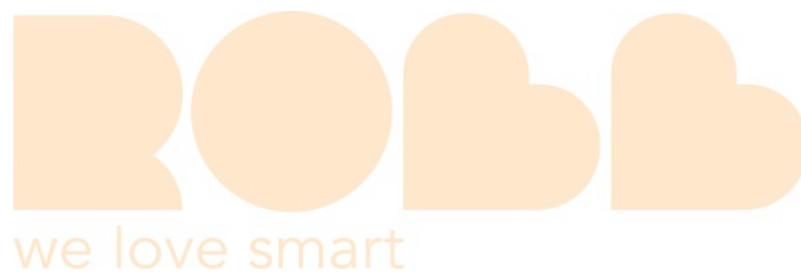

## 7. Obtaining Technical Support

While we hope your experience with the IP camera is enjoyable and easy to use, you may experience some issues or have questions that this User Manual has not answered. If you experience any issues with your FOSCAM devices, please first contact the FOSCAM reseller for assistance. If our reseller cannot provide service, please contact our service department: [support@foscam.com](mailto:support@foscam.com).

1. Tap the **Foscam** icon  on your mobile device.

The Devices page displays.

2. Tap **Sidebar**  > **Support**  > **Foscsam FAQ**.

