

# ZIPABOX ZIGBEE MODULE

QUICK INSTALLATION GUIDE  
v1.0

## TRADEMARKS

Zipato and the Zipato logo are registered Trademarks. All other product names mentioned herein may be trademarks or registered trademarks of their respective companies.

## NOTICE

Although Zipato has attempted to ensure the accuracy of the content of this manual, it is possible that this document may contain technical inaccuracies, typographical, or other errors. Zipato assumes no liability for any error in this publication, and for damages, whether direct, indirect, incidental, and consequential or otherwise, that may result from such error, including, but not limited to loss of data or profits. Zipato provides this publication "as is" without warranty of any kind, either express or implied, including, but not limited to implied warranties of merchantability or fitness for a particular purpose. The published information in the manual is subject to change without notice. Zipato reserves the right to make changes in the product design, layout, and driver revisions without notification to its users. This version of the Installation guide supersedes all previous versions.

## ELECTROMAGNETIC COMPATIBILITY

In proper state and when operated properly, the product complies with all the requirements in respect of interference radiation according to EN 301 489-17, EN 301 489-1 and EN 300 328. The connections conducting HF signals must neither be manipulated nor damaged.

## TAKE CARE OF YOUR SAFETY

Display extreme caution when using ladders or steps, please follow manufacturer's instructions. Be careful when using hand and power tools and follow the manufacturer's guidelines when using them. Take care that the correct tools are used. Wear goggles or protective clothing where required.

## DANGER

### RISK OF ELECTROCUTION

All work on the device should only be carried out by trained and skilled electricians. Observe the country-specific regulations.

## CAUTION

The connected devices and the flush-mounted receiver can become damaged if devices are operated that do not correspond to the technical specifications (see technical data).

## DANGER

### RISK OF FATAL INJURY FROM ELECTRIC CURRENT.

The device has no basic insulation and must therefore be installed in a way that protects against accidental contact.

## DANGER

### RISK OF FATAL INJURY FROM ELECTRIC CURRENT.

When installing a wall plate, the distance between the cover's fixing brackets or screws and the connections of the flush - mounted MicroModule Switch Single must be at least 4 mm once installed. If the distance is less than 4 mm, a deeper installation box must be used. The fixing brackets or screws of the cover must not press against the housing. Only insulated tools may be used for operation on the device, e.g. an insulated phase tester.

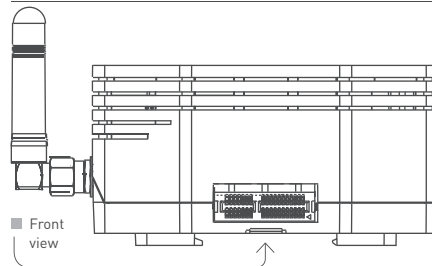
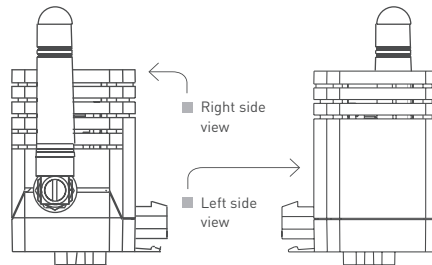
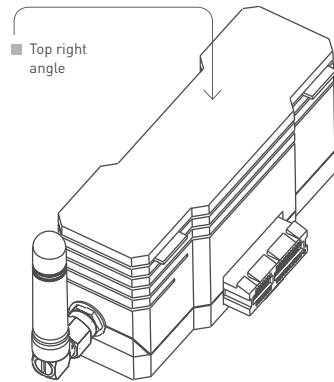

## INTRODUCTION

### COMPATIBILITY

This Expansion Module is designed to work only with Zipabox.

### HANDLING

Do not drop, knock or shake the module. Rough handling can break internal circuit boards and connectors.

### ENVIRONMENT

Do not expose the module to excessive heat or cold, as it can damage or shorten the life of electronic circuit boards.



If possible, dispose this module at a recycling center.  
Do not dispose of this module with the household waste.

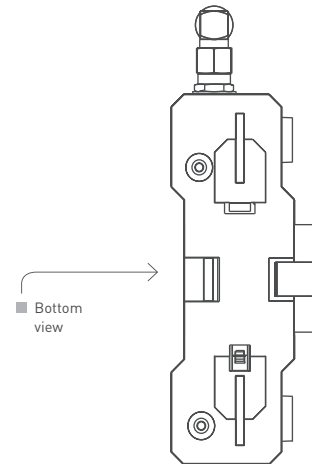
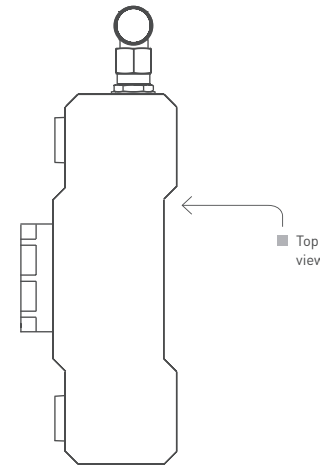

## TECHNICAL MANUALS

### TECHNICAL DETAILS

POWER SUPPLY	From Zipabox
OPERATING TEMPERATURE	-10° ~ +40° C
OPERATING HUMIDITY	5 ~ 95% RH
DIMENSIONS	29 x 87 x 46 mm [without antenna]
WEIGHT	62g [with antenna]
COMMUNICATION PROTOCOL	ZigBee
COMMUNICATION RANGE	Up to 30m indoor or 70m outdoor

### UNPACKING

Zipabox ZigBee Module consists of:  
■ 1x Expansion Module ■ 1x 2.4 GHz antenna

**PLEASE NOTE:** Connect antenna by screwing it clockwise to the connector on the module

### CONNECTING DEVICE

1 | Disconnect Zipabox from power

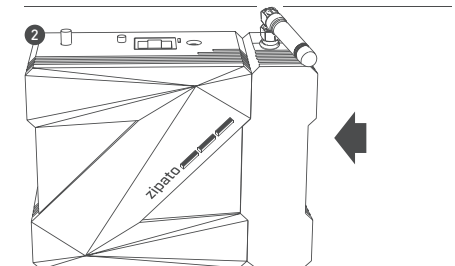
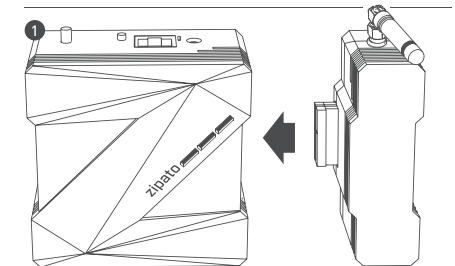
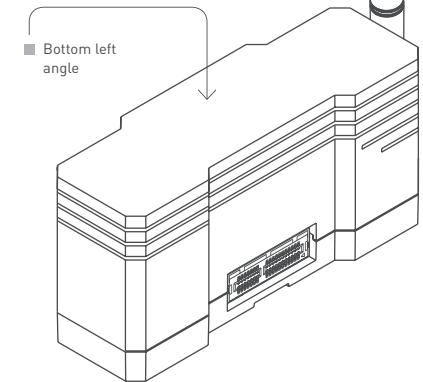

2 | Align connector of ZigBee Module to expansion Slot 2 of Zipabox (or to module connected into Slot 2)

3 | Join module and Zipabox together until gap between them is completely closed.

### INSTALLATION/MOUNTING

Mount together with Zipabox.

### INTERFERENCE

All wireless devices are subject to interference, which could affect device performance.

### REPAIRING

Do not attempt to repair this product.  
There are no user-serviceable parts inside.

### WATER-RESISTANCE

This product is not water-resistant. Keep it dry.  
Moisture will corrode the inner electronics.

### CLEANING

Use a dry cloth to clean this product. Do not use harsh chemicals, cleaning solvents or strong detergents.



# ZIPABOX ZIGBEE MODULE

QUICK INSTALLATION GUIDE  
v1.0

## MODELS AND FREQUENCIES

### MODELS

EUROPEAN UNION - EU version	zbmzigbee.eu
UNITED STATES - US version	zbmzigbee.us
RUSSIA - RU version	zbmzigbee.ru
ISRAEL - IS version	zbmzigbee.is
AUSTRALIA - AU version	zbmzigbee.au
INDIA - IN version	zbmzigbee.in

### FREQUENCIES

EUROPEAN UNION - EU	868.42 MHz
UNITED STATES - US	908.42 MHz
RUSSIA - RU	869.02 MHz
ISRAEL - IS	916.02 MHz
AUSTRALIA - AU	921.42 MHz
INDIA - IN	865.20 MHz

## LIMITED PRODUCT WARRANTY

### GENERAL TERMS

Nothing in this Limited Product Warranty affects your statutory rights as a consumer.

The Limited Product Warranty set forth below is given by Tri plus grupa d.o.o. [Europe] [herein referred to as "ZIPATO"]. This Limited Product Warranty is only effective upon presentation of the proof of purchase. Upon further request by ZIPATO, this warranty card has to be presented, too.

EXCEPT AS EXPRESSLY SET FORTH IN THIS LIMITED WARRANTY, ZIPATO MAKES NO OTHER WARRANTIES, EXPRESS OR IMPLIED, INCLUDING ANY IMPLIED WARRANTIES OF MERCHANTABILITY AND FITNESS FOR A PARTICULAR PURPOSE. ZIPATO EXPRESSLY DISCLAIMS ALL WARRANTIES NOT STATED IN THIS LIMITED WARRANTY. ANY IMPLIED WARRANTIES THAT MAY BE IMPOSED BY LAW ARE LIMITED IN DURATION TO THE LIMITED WARRANTY PERIOD. TO THE EXTENT ALLOWED BY LOCAL LAW, THE REMEDIES IN THIS WARRANTY STATEMENT ARE CUSTOMER'S SOLE AND EXCLUSIVE REMEDIES AGAINST ZIPATO. THEY DO NOT, HOWEVER, AFFECT OR RESTRICT THE RIGHTS YOU HAVE AGAINST THE BUSINESS YOU BOUGHT A ZIPATO PRODUCT FROM. IN NO EVENT WILL ZIPATO BE LIABLE FOR LOSS OF DATA OR FOR INDIRECT, SPECIAL, INCIDENTAL, CONSEQUENTIAL (INCLUDING LOST PROFIT OR DATA), OR OTHER DAMAGE, WHETHER BASED IN CONTRACT, TORT, OR OTHERWISE. HOWEVER, NOTHING IN THIS AGREEMENT LIMITS ZIPATO'S LIABILITY TO YOU (I) IN THE EVENT OF DEATH OR PERSONAL INJURY TO THE EXTENT RESULTING FROM ZIPATO'S NEGLIGENCE, OR (II) TO THE EXTENT RESULTING FROM ANY FRAUDULENT MISREPRESENTATION ON THE PART OF ZIPATO, OR (III) TO THE EXTENT ARISING UNDER PART 1 OF THE CONSUMER PROTECTION ACT 1987 OF THE UNITED KINGDOM. SOME STATES OR COUNTRIES DO NOT ALLOW: (1) A DISCLAIMER OF IMPLIED WARRANTIES; (2) A LIMITATION ON HOW LONG AN IMPLIED WARRANTY LASTS OR THE EXCLUSION; OR (3) LIMITATION OF INCIDENTAL OR

CONSEQUENTIAL DAMAGES FOR CONSUMER PRODUCTS. IN SUCH STATES OR COUNTRIES, SOME EXCLUSIONS OR LIMITATIONS OF THIS LIMITED WARRANTY MAY NOT APPLY TO YOU. THIS LIMITED WARRANTY GIVES YOU SPECIFIC LEGAL RIGHTS. YOU MAY ALSO HAVE OTHER RIGHTS THAT MAY VARY FROM STATE TO STATE OR FROM COUNTRY TO COUNTRY. YOU ARE ADVISED TO CONSULT APPLICABLE STATE OR COUNTRY LAWS FOR A FULL DETERMINATION OF YOUR RIGHTS.

This Limited Product Warranty applies to ZIPATO branded hardware products (collectively referred to as "ZIPATO Hardware Products") sold by ZIPATO [Europe], its European subsidiaries, affiliates, authorized resellers, or country distributors (collectively referred to as "ZIPATO Resellers") with this Limited Product Warranty.

The term "ZIPATO Hardware Product" is limited to the hardware components and all its internal components including firmware. The term "ZIPATO Hardware Product" DOES NOT include any software applications or programs.

### GEOGRAPHICAL SCOPE OF THE LIMITED PRODUCT WARRANTY

This Limited Product Warranty is applicable to Hardware Products sold by Zipato Resellers in all countries listed at the beginning of this document under the heading "Countries in which this ZIPATO Limited Product Warranty applies". The Limited Product Warranty will be honored in any country where ZIPATO or its authorized service providers offer warranty service subject to the terms and conditions set forth in this Limited Product Warranty. However, warranty service availability and response times may vary from country to country and may also be subject to registration requirements.

### LIMITATION OF PRODUCT WARRANTY

ZIPATO warrants that the products described below under normal use are free from material defects in materials and workmanship during the Limited Product Warranty Period set forth below ("Limited Product Warranty Period"), if the product is used and serviced in accordance with the user manual and other documentation provided to the purchaser at the time of purchase (or as amended from time to time).

ZIPATO does not warrant that the products will operate uninterrupted or error-free or that all deficiencies, errors, defects or non-conformities will be corrected.

This warranty shall not apply to problems resulting from: (a) unauthorized alterations or attachments; (b) negligence, abuse or misuse, including failure to operate the product in accordance with specifications or interface requirements; (c) improper handling; (d) failure of goods or services not obtained from ZIPATO or not subject to a then-effective ZIPATO warranty or maintenance agreement; (e) improper use or storage; or (f) fire, water, acts of God or other catastrophic events. This warranty shall also not apply to any particular product if any ZIPATO serial number has been removed or defaced in any way.

ZIPATO IS NOT RESPONSIBLE FOR DAMAGE THAT OCCURS AS A RESULT OF YOUR FAILURE TO FOLLOW THE INSTRUCTIONS FOR THE ZIPATO HARDWARE PRODUCT.

### LIMITED PRODUCT WARRANTY PERIOD

The Limited Product Warranty Period starts on the date of purchase from ZIPATO. Your dated sales or delivery receipt, showing the date of purchase of the product, is your proof of the purchase date. You may be required to provide proof of purchase as a condition of receiving warranty service. You are entitled to warranty service according to the terms and conditions of this document if a repair to your ZIPATO branded hardware is required within the Limited Product Warranty Period.

[Other than in respect of products for domestic use [in particular those listed in the first and last boxes in the table below], this Limited Product Warranty extends only to the original end user purchaser of this ZIPATO Hardware Product and is not transferable to anyone who obtains ownership of the ZIPATO Hardware Product from the original end-user purchaser.

### PRODUCT WARRANTY PERIOD TABLE

PRODUCT TYPE	Zipabox Zigbee module
PRODUCT WARRANTY PERIOD	One (1) year

### IMPORTANT

The content of "Product Type" listed above is subject to change; please refer to the [www.zipato.com](http://www.zipato.com) for latest update.

### PERFORMANCE OF THE LIMITED PRODUCT WARRANTY

If a product defect occurs, ZIPATO's sole obligation shall be to repair or replace any defective Zipato Hardware Product free of charge provided it is returned to an Authorized ZIPATO Service Centre during the Limited Warranty Period.

Such repair or replacement will be rendered by ZIPATO at an Authorized ZIPATO Service Centre. All component parts or hardware products that are replaced under this Limited Product Warranty become the property of ZIPATO. The replacement part or product takes on the remaining Limited Warranty Period of the replaced part or product. The replacement product need not be new or of an identical make, model or part; ZIPATO may in its discretion replace the defective product (or any part thereof) with any reconditioned equivalent (or superior) product in all material respects to the defective product.

### WARRANTOR

Tri plus grupa d.o.o.  
Banjavičeva 11  
10 000 Zagreb  
CROATIA

TEL +385 (0)1 4004 404  
FAX +385 (0)1 4004 405

## DECLARATION OF CONFORMITY

The Manufacturer Tri plus grupa d.o.o. hereby declares that the product:  
Zipabox ZigBee Module [zbmzigbee]



In accordance with the following Directive(s): 2004/108/EC The Low Voltage Directive, 2006/95/EC R&TTE Directive (1999/5/EC) is in conformity with the applicable requirements of the following documents:

- EN 60950-1:2007+A11:2009+A12:2011
- EN 301 489-17 V2.1.1:2010
- EN 301 489-3 V1.4.1:2003
- EN 301 489-1 V1.8.1:2008
- EN 300 328 V1.7.1:2008
- EN 50130-4:1977+A1:2000+A2:2004
- EN 300 220-1 V2.1.1:2006
- EN 300 220-2 V2.1.2:2008

I hereby declare that the equipment named above has been designed to comply with the relevant sections of the above referenced specifications. The unit complies with all applicable Essential Requirements of the Directives.

Person responsible for this declaration:  
Dean Janacek, Certification Manager  
12.09.2013

Changes or modifications not expressly approved Tri plus grupa d.o.o. for compliance could void the user's authority to operate the equipment



### THIS DEVICE COMPLIES WITH PART 15 OF THE FCC RULES.

Operation is subject to the following two conditions:  
1 | this device may not cause harmful interference, and  
2 | this device must accept any interference received, including interference that may cause undesired operation.

Le présent appareil est conforme aux CNR d'Industrie Canada applicables aux appareils radio exempts de licence. L'exploitation est autorisée aux deux conditions suivantes :

- 1 | l'appareil ne doit pas produire de brouillage, et
- 2 | l'utilisateur de l'appareil doit accepter tout brouillage radioélectrique subi, même si le brouillage est susceptible d'en compromettre le fonctionnement.

**NOTE: Changes or modifications not expressly approved by Zipato for compliance could void the user's authority to operate the equipment.** This equipment has been tested and found to comply with the limits for a Class B digital device, pursuant to Part 15 of the FCC Rules. These limits are designed to provide reasonable protection against harmful interference in a residential installation. This equipment generates, uses and can radiate radio frequency energy and, if not installed and used in accordance with the instructions, may cause harmful interference to radio communications. However, there is no guarantee that interference will not occur in a particular installation. If this equipment does cause harmful interference to radio or television reception, which can be determined by turning the equipment off and on, the user is encouraged to try to correct the interference by one or more of the following measures:

- Reorient or relocate the receiving antenna.
- Increase the separation between the equipment and receiver.
- Connect the equipment into an outlet on a circuit different from that to which the receiver is connected.
- Consult the dealer or an experienced radio/TV technician for help.

### TECHNICAL SUPPORT

Having trouble installing your new product?

Zipato's website contains the latest user documentation and software updates for Zipato products and services.

[www.zipato.com](http://www.zipato.com)

### CALL SUPPORT

CONTACT LINE  
+385 (0)1 4004 404  
(Mon-Fri) 9.00am-05.00pm (CET)

### COPYRIGHT

© 2013 Tri plus grupa d.o.o. All Rights Reserved.

No part of this manual may be reproduced or transmitted in any form without the expressed, written permission of Tri plus grupa d.o.o.