

# heatmiser®



neoStat

Model: **neo**Stat

Available in : Sapphire Black and Glacier White





# Table of Contents

Product Image	1	Frost Protection	20
Table of Contents	2	Power ON/OFF	21
What is a Programmable Room Thermostat?	3-4	Holiday Programming	22
Installation Procedure	5-6	Optional Features	23-26
Mode Select	7	Re-calibrating the Thermostat	27
Pairing the neoHub	8	Error Codes	27
Pairing the neoStat	8-9	Thermostat Mode Wiring Diagrams	28-31
What is a Mesh Network?	9	Factory Reset	32
<b>Mode 1 - Thermostat</b>	<b>10</b>	<b>Mode 2 - Time Clock</b>	<b>33</b>
LCD Display	11-12	LCD Display	33-34
Temperature Display	13	Setting the Switching Times	35
Setting the Clock	14	Timer Override	36
Setting the Comfort Levels	15-16	Optional Features	37
Setting the Temperature	17	Optional Features Table	37
Temperature Hold	18	Time Clock Mode Wiring Diagram	38
Locking/Unlocking the neoStat	19	Battery Replacement	39

## ? What is a Programmable Room Thermostat?

A programmable room thermostat is both a programmer and a room thermostat.

A programmer allows you to set “On” and “Off” periods to suit your own lifestyle.

A room thermostat works by sensing the air temperature, switching on the heating when the air temperature falls below the thermostat setting, and switching it off once this set temperature has been reached.

So a programmable room thermostat lets you choose what times you want the heating to be on, and what temperature it should reach while it is on. It will allow you to select different temperatures in your home at different times of the day (and days of the week) to meet your particular needs and preferences.

Setting a programmable room thermostat to a higher temperature will not make the room heat up any faster. How quickly the room heats up depends on the design and size of the heating system.

Similarly reducing the temperature setting does not affect how quickly the room cools down. Setting a programmable room thermostat to a lower temperature will result in the room being controlled at a lower temperature, and saves energy.

The way to set and use your programmable room thermostat is to find the lowest temperature settings that you are comfortable with at the different times you have chosen, and then leave it alone to do its job.

The best way to do this is to set the room thermostat to a low temperature – say 18°C, and then turn it up by 1°C each day until you are comfortable with the temperature. You won't have to adjust the thermostat further. Any adjustment above this setting will waste energy and cost you more money.

You are able to temporarily adjust the heating program by overriding or using the temperature hold feature. These features are explained further on pages 17 and 18 of this manual.

Programmable room thermostats need a free flow of air to sense the temperature, so they must not be covered by curtains or blocked by furniture. Nearby electric fires, televisions, wall or table lamps may also prevent the thermostat from working properly.



## Installation Procedure



### Do

Mount the thermostat at eye level.

Read the instructions fully so you get the best from our product.



### Don't

Do not install near to a direct heat source as this will affect functionality.

Do not push hard on the LCD screen as this may cause irreparable damage.

*This neoStat is designed to be flush mounted and requires a back box of 35mm (minimum depth) to be sunk into the wall prior to installation.*

### Step 1

Remove the screw from the bottom face of the thermostat then carefully separate the front half from the back plate.

### Step 2

Place the thermostat front somewhere safe.

Terminate the thermostat as shown in the diagrams on pages 28-31 of this booklet.

Note: For time clock wiring connections, terminate as shown on page 38.

### Step 3

Screw the thermostat back plate securely into the back box.

### Step 4

Clip the front of the thermostat onto the back plate, securing it in place with the retaining screw.

1



2

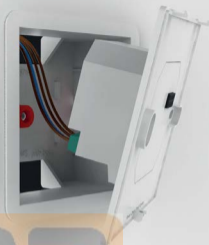

3



4





## Mode Select

This neoStat can either be used as a thermostat or a time clock.  
Thermostat mode is the default setting.

To change between thermostat or time clock modes, follow these steps.

- Use the Left / Right keys to scroll to SETUP ..... <>
  - Press and hold the Tick button for 10 seconds ..... ✓
  - Use the Left / Right keys to scroll between modes ..... <>
- Mode 1 = Thermostat  
Mode 2 = Time Clock  
*Note: the selected option will flash.*
- Press the Tick key to confirm selection ..... ✓

The neoStat will revert to the main display screen for the selected mode.

For time clock mode instructions, first pair the time clock with the neoHub as explained on page 8, then turn to page 33.





## Pairing the neoHub

To pair the neoHub with the neoApp, follow these steps.

- Connect the power supply to the neoHub.
- Connect the neoHub to your router with the Ethernet cable provided. The router will automatically assign an IP address to the neoHub, the Link LED will light up once the neoHub has connected to your network.
- Connect your smartphone or tablet device to the same WiFi network as your router.
- Download the FREE Heatmiser neoApp from the Apple App Store, Google Play Store, Amazon App Store or Windows Phone App Store and register an account.
- Once you have registered your account, press the Login button then press the Add Location option.
- Press the connect button on the neoHub to add the location to your account.
- When successfully connected, enter a title for the new location (e.g. Home) and configure the time zone for the system.



## Pairing the neoStat

The next step is to join the neoStat to the neoHub, we recommend joining the neoStat located nearest to the neoHub first.

To add a neoStat, follow these steps;

- Select Add Zone, enter a zone title and press Add Zone again.
- You now have two minutes to join the neoStat to the neoHub.
- On the neoStat, use the Left / Right keys to select SETUP and press Tick ... < > ✓
- Feature 01 is displayed on screen.

- Press the Tick key to pair the neoStat to the neoHub ..... ✓
- The MESH symbol appears flashing on the display.
- When the neoStat successfully connects to the neoHub the MESH symbol will be permanently displayed.
- Press Next to add more zone or press Finish to complete the setup.

*Please note, you only have to pair the hub to your account once. To pair any additional neoStats, select Add Zones from the Manage Zones option in the neoApp.*

## ? What is a Mesh Network

NeoStats work using a mesh network, meaning neoStats have the ability to send & receive signals via other thermostats on the network. This signal is relayed from one thermostat to another until it reaches its destination. This communication method extends the communication range whilst offering increased network stability when compared with standard RF thermostats.

The Mesh symbol is shown when the device is communicating with the neoHub, if the mesh symbol disappears this indicates connection to the neoHub has been lost.

# 1 Mode 1 - Thermostat



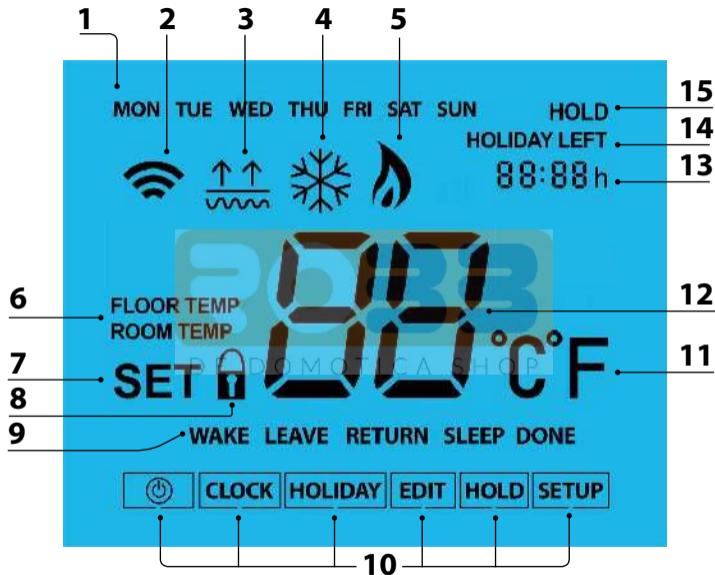

1. Day Indicator - Displays the day of the week.
2. Mesh Symbol - Displayed when connected to the neoHub.
3. Floor Limit Symbol - Displayed when the floor probe has reached the temperature limit set on feature 07.
4. Frost Symbol - Displayed when frost protection mode is active.
5. Flame Symbol - Displayed when the thermostat is calling for heat, flashes when optimum start is active.
6. Floor/Room Temp - Indicates the current sensor mode.
7. Set - Displayed when changes are being made to the program schedule or current set point.
8. Key Lock Indicator - Displayed when the KeyLock is Locked.
9. Program Indicator - Displayed during programming to show which period is being altered.
10. Main Menu - Displays which option is currently selected.
11. Temperature Format - Degrees Celsius or Fahrenheit.
12. Temperature - Displays the current sensor temperature.
13. Clock - Time displayed in 24 hour format.
14. Holiday Left - Displayed when the thermostat is in holiday mode.
15. Hold Left - Displayed when a temperature hold is active, the remaining time will be shown.

# Temperature Display

This neoStat can be configured for different sensor options such as built in air sensor, floor sensor or both. The display will clearly indicate which sensor is being used by showing either "Room Temp" or "Floor Temp" before the actual temperature value.

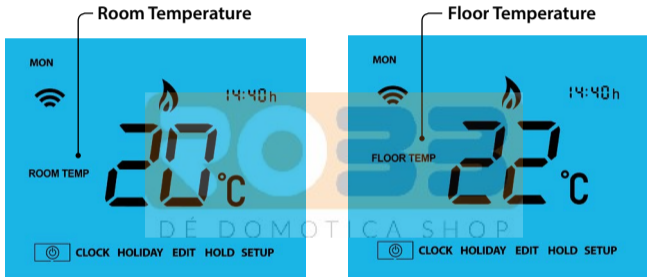

When the neoStat is set to use both the air & the floor sensor, the room temperature will be displayed by default.

To view the current floor temperature, press and hold the Left and Right arrow keys for 5 seconds, the floor temperature will then be displayed ..... <>



# Setting the Clock

To set the clock, follow these steps.

- Use the Left / Right keys to scroll to CLOCK ..... <>
- Press Tick to confirm selection ..... ✓
- Use the Up / Down keys to set the hours (24 hour format) ..... ^v
- Press Tick to confirm selection ..... ✓
- Use Up / Down keys to set the minutes ..... ^v
- Press Tick to confirm selection ..... ✓
- Use Left / Right keys to set the day ..... <>
- Press Tick to confirm selection and return to the main display ..... ✓

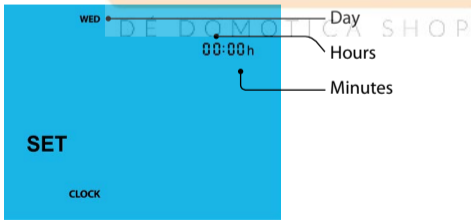



## Comfort Levels Explained

The neoStat offers three program mode options; Weekday/Weekend programming, 7 Day programming and 24 Hour programming. There is also the option to use the thermostat as a Non-Programmable thermostat.

When thermostats are connected to the mesh network, the program mode for the system is configured by using the neoApp.

The thermostat is supplied with comfort levels already programmed, but these can be changed easily. The default times and temperature settings are;

07:00 - 21°C (Wake) 09:00 - 16°C (Leave) 16:00 - 21°C (Return) 22:00 - 16°C (Sleep)

If you only want to use 2 levels, you should program the unused levels to --:--

*For Weekday/Weekend programming, the four comfort levels are the same for Mon-Fri, but can be different for Sat-Sun. For 7 Day programming each day of the week can have four different comfort levels. In 24 Hour mode all days are programmed with the same comfort levels.*

- To program the comfort levels, use the Left / Right keys to scroll to EDIT ..... < >
- Press Tick to confirm selection ..... ✓
- Use the Left / Right keys to select day / period of week (the selection will flash). < >
- Press Tick to confirm selection ..... ✓
- WAKE will now flash and the current time and temperature setting will be shown.
- Press Tick to alter WAKE settings ..... ✓



- Use the Up / Down keys to set the hours ..... ^ v
- Press Tick to confirm ..... ✓
- Use the Up / Down keys to set the minutes ..... ^ v
- Press Tick to confirm ..... ✓
- Use the Up / Down keys to set the temperature ..... ^ v
- Press Tick to confirm the settings ..... ✓
- Press the right arrow key ..... >
- LEAVE will now flash and the current settings will be displayed.
- Press Tick to alter LEAVE settings ..... ✓
- Repeat these steps to set all comfort levels.
- For any unused periods set time to --:--
- Use the Left / Right keys to scroll to DONE and press Tick ..... < > ✓



## Temperature Control

The Up / Down keys allow you to adjust the set temperature ..... ^ V

When you press either key, you will see the word SET and the desired temperature value. Use the Up / Down keys to adjust the SET value ..... ^ V

Press Tick to confirm settings and return to the main display ..... ✓

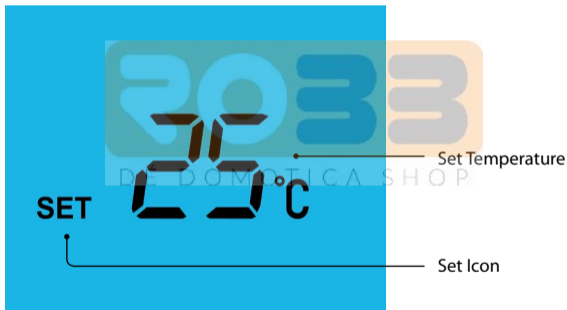

*Note: This new temperature is maintained only until the next programmed comfort level. At this time, the thermostat will revert back to the programmed levels.*



## Temperature Hold

The temperature hold function allows you to manually override the current operating program and set a different temperature for a desired period.

- Use the Left / Right keys to scroll to HOLD ..... <>
- Press Tick to confirm selection ..... ✓
- Use the Up / Down keys to set the desired Hold period ..... ^v
- Press Tick to confirm selection ..... ✓
- Use the Up / Down keys to set the desired Hold temperature ..... ^v
- Press Tick to confirm selection ..... ✓

You will see the HOLD LEFT indication is displayed on screen.

The time will countdown the set duration and then revert to the normal program.

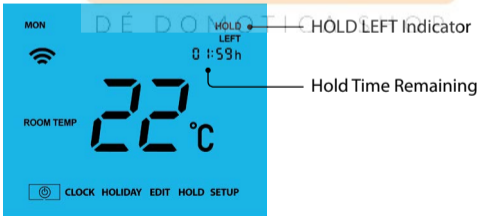

To cancel a temperature Hold, repeat these steps but reduce the Hold time to 00:00 hrs.



## Locking the neoStat

The thermostat has a keypad lock facility. To activate the lock follow these steps.

- Use the Left / Right keys to scroll to HOLD & press Tick for 10 seconds. < > ✓
- The display will show 00:00 and you will need to enter a four digit pin number.
- Use the Up / Down keys to enter the first two digits ..... ^ v
- Press Tick to confirm ..... ✓
- Use the Up / Down keys to enter the second two digits ..... ^ v
- Press Tick to confirm ..... ✓

The display will return to the main screen and display the keypad lock indicator .....

*Note: The keypad lock indicator is only displayed when the lock is active.*



## Unlocking the neoStat



To unlock the neoStat press Tick once. The display will show 00:00 and you will need to enter the four digit pin number you set previously.

- Use the Up / Down and Tick keys to enter the first two digits ..... ^ v ✓
- Use the Up / Down and Tick keys to enter the second two digits ..... ^ v ✓

The display will unlock and return to the main screen.



## Frost Mode

Use the Left / Right keys to scroll to the Power Icon .....     
The frost icon will toggle ON/OFF each time Tick is pressed ..... ✓

In this mode, the neoStat will display the frost icon and will only turn the heating ON should the room temperature drop below the set frost temperature (see page 23). If the heating is turned ON whilst in frost mode, the flame symbol will be displayed.

To cancel the frost protect mode, navigate to the Power button again and press Tick. ✓



Frost Protection Mode Enabled



## Power On/Off

The heating is indicated ON when the flame icon is displayed.

When the flame icon is absent, there is no requirement for heating to achieve the set temperature but the neoStat remains active.

To turn the neoStat off completely, scroll to the Power Icon and hold the Tick key for approximately 4 seconds until the display goes blank ..... < > ✓

The display and heating output will be turned OFF.

To turn the thermostat back ON, press the Tick key once ..... ✓

Thermostat completely OFF



Thermostat powered ON





## Holiday

In thermostat mode, the holiday function reduces the set temperature in your home to the frost protection temperature setting (see page 23).

In time clock mode, the holiday function maintains the timed output as OFF.

The thermostat will maintain this temperature for the duration of the holiday and will then automatically return to the program mode on your return.

- Use the Left / Right keys to scroll to HOLIDAY and press Tick ..... < > ✓
- Using the Up / Down keys enter the number of days holiday ..... ^ v
- Press Tick to confirm settings ..... ✓

*Note: A holiday period does not start until 00:00 the next day. For example, if you set a holiday period on Friday for 2 days, Saturday will be counted as the first day and the thermostat will revert back to the programmed schedule at 00:00 on Monday.*

To cancel, repeat these steps but reduce the Holiday duration to 00 days.



## Optional Features Explained

### THE FOLLOWING SETTINGS ARE OPTIONAL AND IN MOST CASES NEED NOT BE ADJUSTED

**Feature 01 – Pairing To neoHub:** This function is used to connect the thermostat to the neoHub.

**Feature 02 - Switching Differential:** This function allows you to increase the switching differential of the thermostat. The default is 1°C which means that with a set temperature of 20°C, the thermostat will switch the heating on at 19°C and off at 20°C. With a 2°C differential, the heating will switch on at 18°C and off at 20°C.

**Feature 03 - Frost Protect Temperature:** This is the temperature maintained when the thermostat is in Frost Mode. The range is 07 - 17°C. The default is 12°C and is suitable for most applications.

**Feature 04 – Output Delay:** To prevent rapid switching, an output delay can be entered. This can be set from 00 - 15 minutes. The default is 00 which means there is no delay.

**Feature 05 – Temperature Up/Down Limit:** This function allows you to limit the use of the up and down temperature arrow keys. This limit is also applicable when the thermostat is locked and so allows you to give others limited control over the heating system.

**Feature 06 – Sensor Selection:** On this neoStat, you can select which sensor should be used. You can select between air temperature only, floor temperature, or both. When you enable both sensors, the floor sensor is used as a floor limiting sensor and is designed to prevent the floor from overheating.



**Feature 07 – Floor Temp Limit:** This function is available when mode 07 is set to 03 or 04. You can set a floor limiting temperature between 20–45°C (28°C is the default setting).  
**Note:** Air Sensor only **MUST NOT** be used to control electric under-floor heating. Floor Sensor or Both should be used.

**Feature 08 – Optimum Start:** Optimum start will delay the start up of the heating system to the latest possible moment to avoid unnecessary heating and ensure the building is warm at the programmed time. The thermostat uses the rate of change information to calculate how long the heating needs to raise the building temperature 1°C (with a rate of change of 20, the thermostat has calculated the heating needs 20 minutes to raise the building temperature 1°C) and starts the heating accordingly.

**Feature 09 – Rate of Change:** Number of minutes for 1°C temperature rise.

**Feature 10 – Not used on this model.**

**Feature 11 – Not used on this model.**

**Feature 12 – Program Mode:** Non-Programmable, Weekday/Weekend (5/2), 7 Day Programming or 24 Hour. The thermostat offers three programming modes and the option of configuring it to work as a non-programmable thermostat.

**Weekday/Weekend** - allows you to program 4 comfort levels for the weekday and 4 different comfort levels for the weekend.

**7 Day Program Mode** - Each day has 4 comfort levels that can be programmed independently.

**24 Hour Mode** - All days are programmed the same and repeat continuously.

**Feature 13 - Temperature Format:** This function allows you to select between °C and °F.



## Adjusting the Optional Settings

- Use the Left / Right keys to select SETUP .....
- Press Tick to confirm selection .....

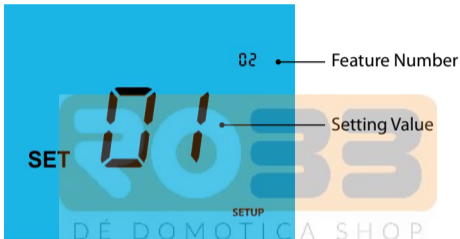

- Use the Up / Down keys to scroll through features .....
- Use the Left / Right keys to adjust the setting within each feature .....
- Press Tick to confirm settings .....











## Optional Settings - Feature Table

FEATURE	DESCRIPTION	SETTING
01	Pairing	Used to add zone to the neoHub
02	Switching Differential	00 = 0.5°C 01 = 1.0°C (Default) 02 = 2.0°C 03 = 3.0°C
03	Frost Protection Temperature	07° - 17°C (12°C = Default)
04	Output Delay	00 - 15 Minutes (00 = Default)
05	Up/Down Temperature Limit	00° - 10°C (00 = Default)
06	Sensor Selection	00 = Built in Sensor (Default) 01 = Remote Air Sensor 02 = Floor Sensor Only 03 = Built in & Floor Sensor 04 = Remote Air & Floor Sensor
07	Floor Temperature Limit	20°C - 45°C (28°C = Default)
08	Optimum Start	00 - 05 Hours (00 = Default)
09	Rate of Change	Minutes to raise by 1°C
10	Not used on this model	
11	Not used on this model	
12	Program Mode	00 = Non - Programmable 01 = Weekday/Weekend (Default) 02 = 7 Day Programming 03 = 24 Hour Mode
13	Temperature Format	00 = °C, 01 = °F (00 = Default)



## Re-calibrating the Thermostat

If you need to re-calibrate the thermostat, follow these steps.

- Use the Left / Right keys to scroll to the Power Icon .....   
- Press and hold Tick to turn the display OFF ..... ✓
- Press and hold the Tick and Down keys together for 10 seconds ..... ✓ 
- The current temperature will appear on the display.
- Use the Up / Down keys to configure the new temperature value .....  
- Press the Tick key to confirm the change and the display will go blank .... ✓
- Press the Tick key once to turn the thermostat ON ..... ✓



## Error Codes

When terminated for thermostat operation the screen will display an error code if a fault is detected.

E0 = The internal sensor has developed a fault.

E1 = The remote FLOOR probe has not been connected.  
The remote FLOOR probe has not been wired correctly.  
The remote FLOOR probe is faulty.

E2 = The remote AIR probe has not been connected.  
The remote AIR probe has not been wired correctly.  
The remote AIR probe is faulty.



## Wiring Diagram - neoStat to Boiler S/L

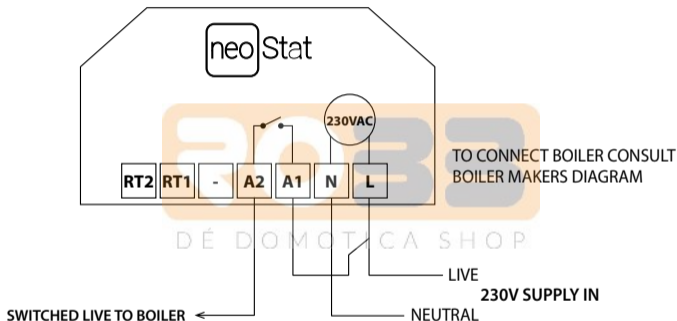

This product must only be installed by a qualified electrician and comply with local installation regulations.



## Wiring Diagram - neoStat to Boiler Voltfree

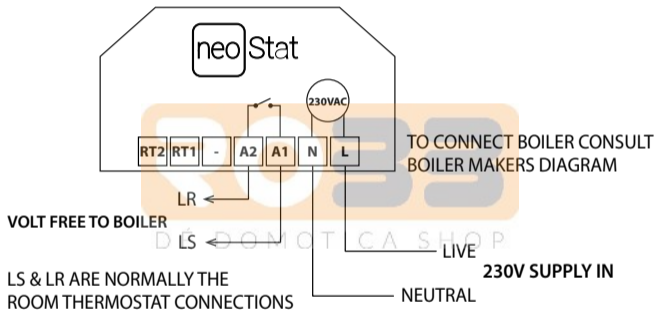

This product must only be installed by a qualified electrician and comply with local installation regulations.



## Wiring Diagram - neoStat to Valve

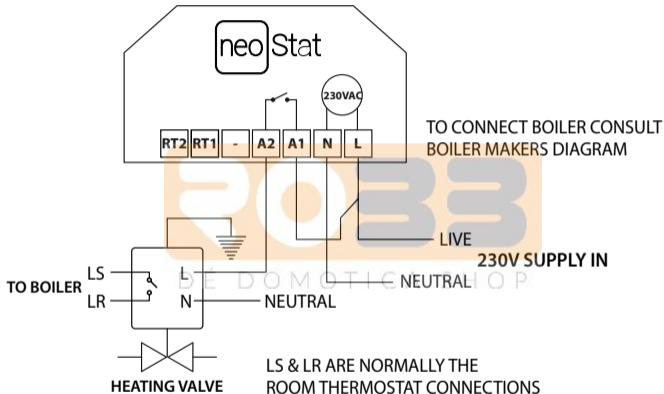

This product must only be installed by a qualified electrician and comply with local installation regulations.



# Wiring Diagram

## neoStat to UH8 and Optional Remote Probe Connections

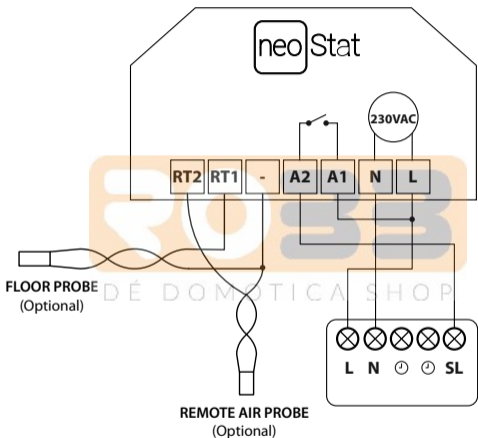

This product must only be installed by a qualified electrician and comply with local installation regulations.





## Factory Reset

To reset the device to factory default settings, follow these steps:

- Use the Left / Right keys to scroll to SETUP ..... <>
- Press and hold the Tick key for 10 seconds ..... ✓
- All of the icons on the display will appear for 2 seconds, then the display will show option 1 or 2.
- Use the Left / Right keys to scroll between modes (selection will flash) .... <>
  - Mode 1 = Thermostat
  - Mode 2 = Time Clock
- Press the Tick key to confirm selection ..... ✓

The thermostat will revert to the main display screen for the selected mode.

*Note: Factory reset will cancel all parameters that were entered during the set-up and pairing operations. These processes must be repeated after factory reset is completed.*

# 2

## Mode 2 - Time Clock

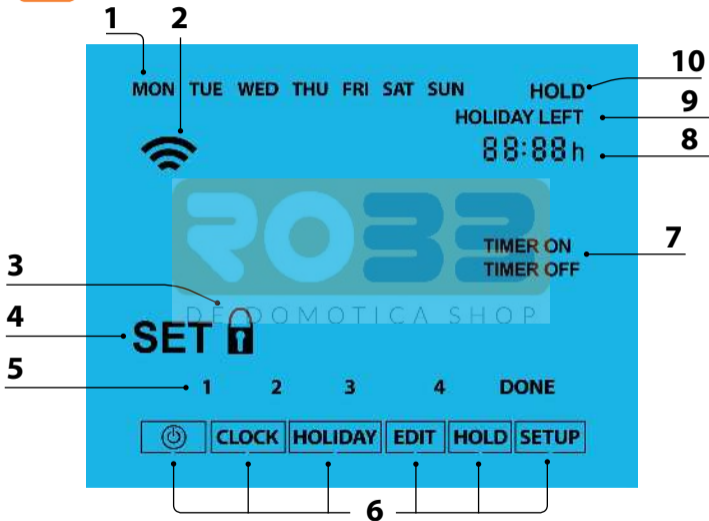

1. Day Indicator – Displays the day of the week.
2. Mesh Symbol – Displayed when connected to the neoHub.
3. Key Lock Indicator – Displayed when the KeyLock is Locked.
4. Set – Displayed when changes are being made to the program schedule or current set point.
5. Program Indicator – Displayed during programming to show which period is being altered.
6. Main Menu – Displays which option is currently selected.
7. Timer Status – Displays the current state of the timed output.
8. Clock – Time displayed in 24 hour format.
9. Holiday Left – Displayed when the thermostat is in holiday mode.
10. Hold Left – Displayed when a temperature hold is active, the remaining time will be shown.



## Setting the Switching Times

To program the switching times, follow these steps.

- Use the Left / Right keys to scroll to EDIT and press Tick ..... < > ✓
- Use the Left / Right keys to select day/period of the week ..... < >
- Press Tick to confirm selection ..... ✓
- 1 will now flash and the current ON time will be displayed.  
The OFF time can be viewed by pressing the Down key ..... V
- Select a switching time and press the Tick key ..... ✓
- Use the Up / Down keys to select the ON time HOURS and press Tick ..... ^ V ✓
- Use the Up / Down keys to select the ON time MINUTES ..... ^ V
- Press Tick to confirm selection ..... ✓
- Use the Up / Down keys to select the OFF time HOURS and press Tick ..... ^ V ✓
- Use the Up / Down keys to select the OFF time MINUTES ..... ^ V
- Press Tick to confirm selection ..... ✓
- Press the Right arrow key ..... >
- 2 will now flash and the current ON time will be displayed.
- Repeat the steps above to set all periods. For any unused periods enter -- :-
- When complete, use the Left / Right keys to scroll to DONE and press Tick to confirm all changes ..... < > ✓



## Timer Override

To override the timed output on, follow these steps.

- Use the Up / Down keys to set the override duration e.g. 02:00 hours .....
- Press Tick to confirm settings and return to main display .....



Hold Left and the remaining time will now be displayed.

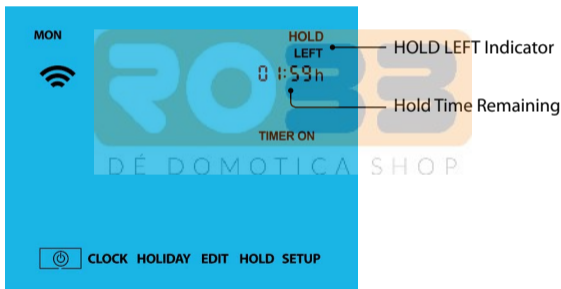



## Optional Features Explained

**Feature 01 – Pairing To neoHub:** This function is used to connect the time clock to the neoHub.

**Feature 02 - Weekday/Weekend (5/2), 7 Day Programming or 24 Hour Mode:**  
The time clock offers three programming methods;

**Weekday/ Weekend (5/2)** - Allows you to program 4 on/off switching times for the weekdays and 4 on/off switching times for the weekend.

**7 Day Program Mode** - Each day has 4 on/off switching times that can be programmed independently.

**24 Hour Mode** - All days are programmed with the same on/off switching times.



## Optional Settings - Feature Table

FEATURE	DESCRIPTION	SETTING
01	Pairing	Used to pair to the neoHub
02	Program Mode	01 = Weekday/Weekend Programming (Default) 02 = 7 Day Programming 03 = 24 Hour Mode



## Wiring Diagram - Time Clock Mode

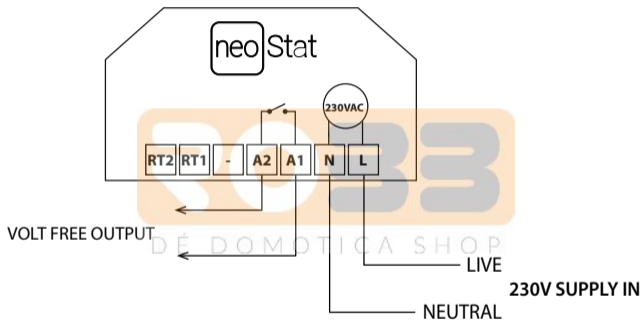

FOR 230V OUTPUT ON A2  
LINK LIVE TO A1

This product must only be installed by a qualified electrician  
and comply with local installation regulations.



## Replacing the Battery

In most cases the 3 volt lithium battery does not need replacing if the thermostat has a continual power supply. Its sole purpose is to ensure correct time keeping during a power loss to the thermostat.

To remove the battery use a small flat head screw driver or fingertip to push back the brass retaining bracket. This will automatically release the battery.

Insert the new battery (**positive side up!**) by locating one end underneath the **holding clips** then pushing down on the opposite end against the brass holding bracket.



We advise that replacement of the lithium battery be carried out by a qualified professional.





## Notes



DÉ DOMOTICA SHOP



## Notes



DÉ DOMOTICA SHOP



## Notes



DÉ DOMOTICA SHOP



## Want More Information?

Call our support team on: +44 (0)1254 669090

Or view technical specifications directly on our website:  
[www.heatmiser.com](http://www.heatmiser.com)



PDF



FAQ



Twitter: @heatmiseruk



Facebook: facebook.com/thermostats