

ZigBee Wireless Dimmer Switch

09.ZGK2D.04837



Important: Read All Instructions Prior to Installation

Function introduction

Press and hold down both keys together to search and pair to ZigBee network or factory reset the dimmer switch.

Click to turn on the paired lighting devices, press and hold down to increase light intensity

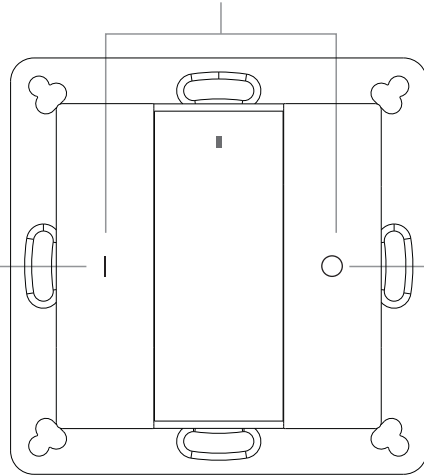

Click to turn off the paired lighting devices, Press and hold down to decrease light intensity

Note: This switch supports 1 group for binding max. 30 lighting devices.

Front side

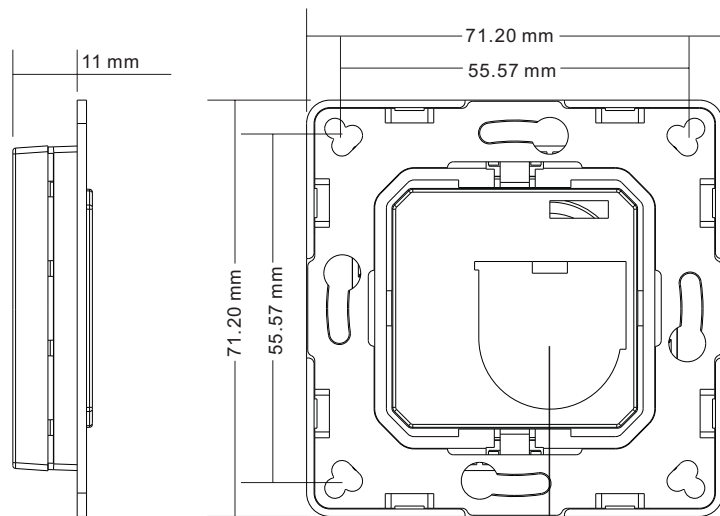

Battery: CR2450
Before the first use, please open the battery cover and remove the protective film

Back side

Product Data

Protocol	ZigBee 3.0
Operation Voltage	3VDC (CR2450)
Transmission Frequency	2.4GHz
Transmission Range (free field)	30m
Protection Type	IP20
Dimming Range	0.1%-100%
Dimensions	71.2x71.2x13.6mm

- ZigBee dimmer switch based on ZigBee 3.0
- Enables to pair ZigBee lighting devices via touchlink commissioning without coordinator
- Supports find and bind mode to pair with ZigBee lighting devices in the same network
- Supports 1 group for binding max. 30 lighting devices
- 2.4 GHz global operation
- Long battery life mesh technology
- Transmission range up to 30m
- Compatible with universal ZigBee Gateway products
- Compatible with universal single color ZigBee lighting devices

ZigBee Clusters Supported by This Remote Are As Follows:

Input clusters:

- Basic
- Power Configuration
- Identify
- Diagnostics

Output clusters:

- Identify
- On/off
- Level control
- Ota

Safety & Warnings

- This device contains a button lithium battery that shall be stored and disposed properly.
- DO NOT expose the device to moisture.

Operation

1. This ZigBee dim remote is a wireless transmitter that communicates with a variety of ZigBee compatible systems. This transmitter sends wireless radio signals that are used to remotely control a compatible system.

2. This ZigBee remote supports 1 group for binding max. 30 lighting devices and enables to control single color ZigBee lighting devices.

3. Zigbee Network Pairing through Coordinator or Hub (Added to a Zigbee Network)

Step 1: Remove the remote from previous zigbee network if it has already been added to it, otherwise pairing will fail. Please refer to the part "Factory Reset Manually".

Step 3: Press and hold down both until LED indicator turns on.

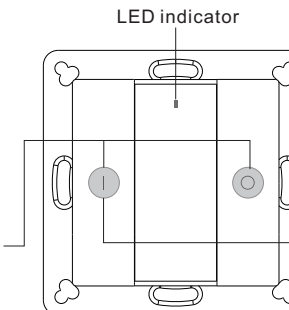

Step 2: From your zigbee controller or hub interface, choose to add device or accessory and enter Pairing mode as instructed by the controller.

Step 4: Immediately short press to search nearby network, indicator flashes every 1 second, 20 seconds timeout if there is no network. Indicator will then blink 5 times quickly for successful pairing.

Note: 1) After pairing successfully, the remote information will appear on the controller or hub interface.

2) No remote information will appear on the hub interface if pairing to Philips Hue Bridge.

4. TouchLink to a Zigbee Lighting Device

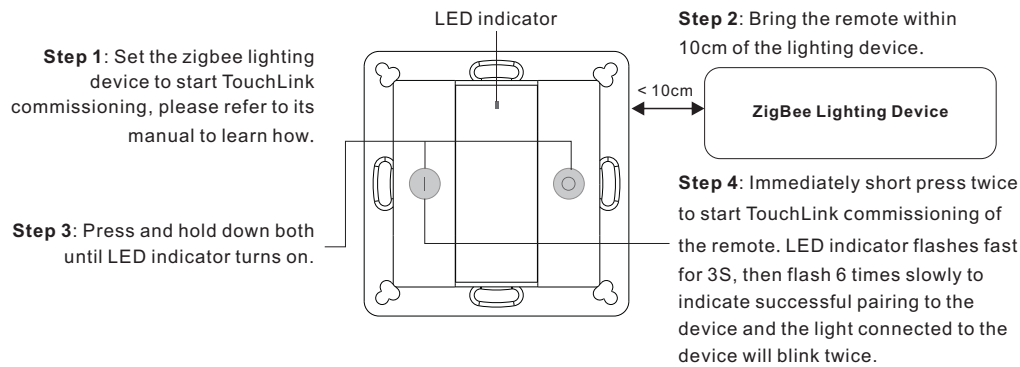

Note: 1) Directly TouchLink (both not added to a ZigBee network), each remote can link with 30 devices.

2) TouchLink after both added to a ZigBee network, each remote can link with max. 30 devices.

3) For Hue Bridge & Amazon Echo Plus, add remote and device to network first then TouchLink.

4) After TouchLink, the remote can control the linked lighting devices.

5. Removed from a Zigbee Network through Coordinator or Hub Interface

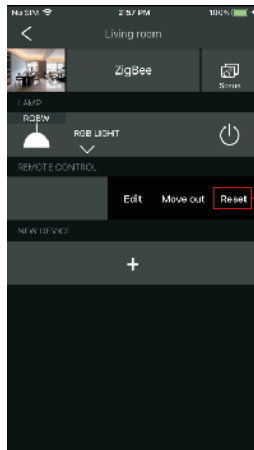

From your ZigBee controller or hub interface, choose to delete or reset the remote as instructed, indicator flashes 3 times quickly to indicate successful removing.

6. Factory Reset Manually

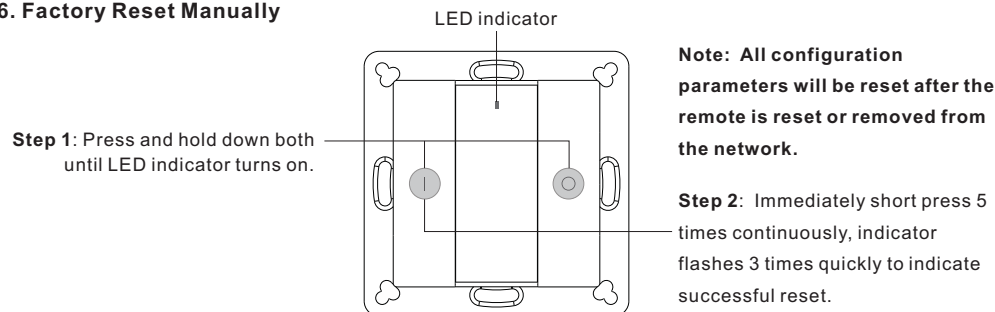

7. Remove a Touchlink Paired ZigBee Lighting Device

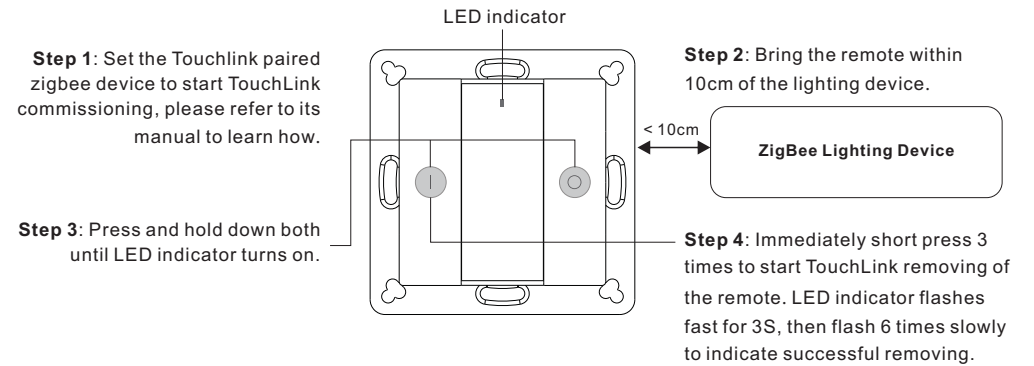

8. Factory Reset a Lighting Device (Touch Reset)

Note: the device shall be added to a network, the remote added to the same one or not added to any network.

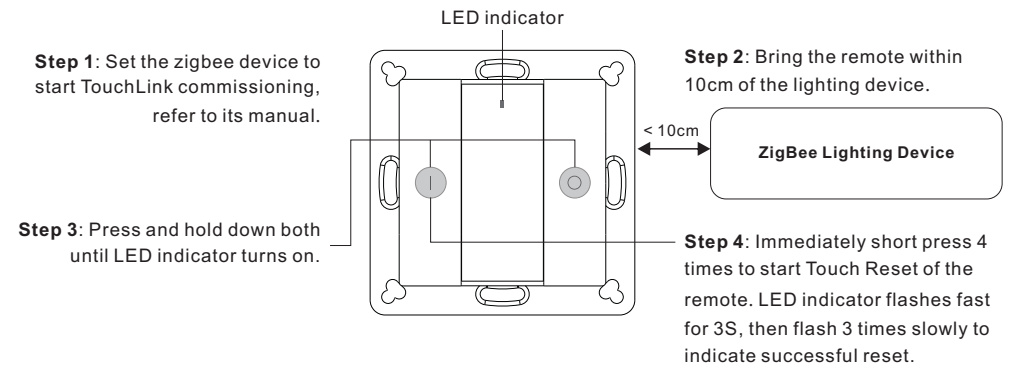

9. Find and Bind a Zigbee Lighting Device

Note: Make sure the device and remote already added to the same zigbee network.

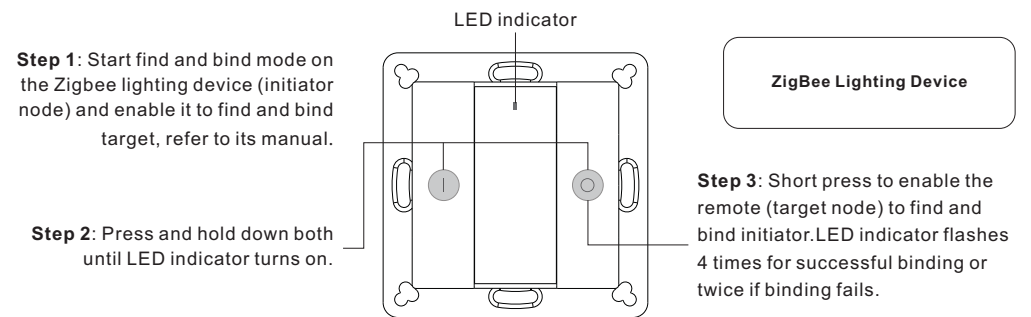

Note: Each remote can bind max. 30 lighting devices.

10. Find and Unbind a Zigbee Lighting Device

Step 1: Start find and bind mode on the Zigbee lighting device (initiator node) and enable it to find and bind target, refer to its manual.

Step 2: Press and hold down both until LED indicator turns on.

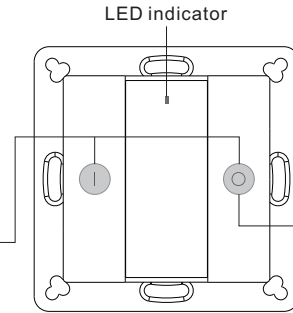

Step 3: Short press twice to enable the remote (target node) to find and unbind initiator. LED indicator flashes 4 times for successful unbinding or twice if unbinding fails.

11. Clear All Find and Bind Mode Paired Lighting Devices

Step 1: Press and hold down both until LED indicator turns on.

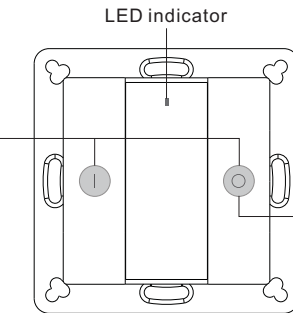

Step 2: Short press 5 times continuously to clear all bound lighting devices. LED indicator flashes 4 times for successful unbinding.

12. Setup a Network & Add Devices to the Network (No Coordinator or Hub Required)

Step 1: Factory reset the remote and the lighting device, refer to their manuals.

Step 3: Short press button to enable the network to discover and add devices, LED indicator will flash twice. 180 seconds timeout, repeat the operation.

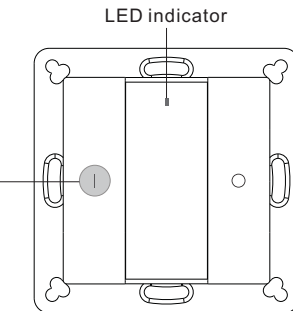

Step 2: TouchLink the remote and device to setup a network, refer to their manuals.

Step 4: Set another remote into network pairing mode and pair it to the network, refer to its manual.

Step 5: Add more remotes to the network as you would like.

Step 6: Factory reset the lighting devices that you would like to add to the network, refer to their manuals.

Step 7: Touchlink to pair the added remotes and lighting devices you would like to add, the devices will be added to the network through Touchlink, refer to their manuals.

13. OTA

The remote supports firmware updating through OTA, and will acquire new firmware from zigbee controller or hub every 10 minutes automatically.

14. How to Check Whether the Remote Belongs to a Network or not

Short press any button, indicator blinking means the remote has already been added to a network. No blinking of indicator means the remote does not belong to any network.

15. Battery Power Monitor Function

The remote will report battery power value to the coordinator under following situations:

- When powered on.
- When short pressing both | and ○ buttons simultaneously.
- When operating the switch to send data packets (over 4 hours since last operation).
- When added to the network by a coordinator.

Installation

1. Remove battery insulator

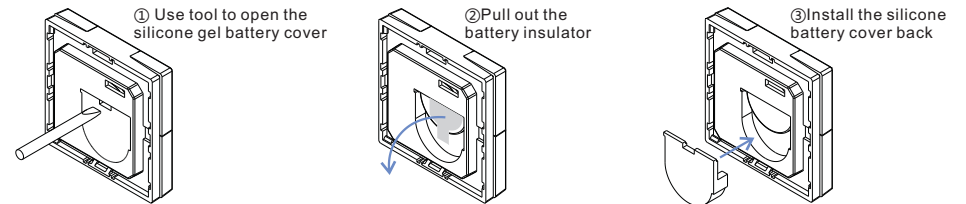

2. Install the controller to wall (2 methods)

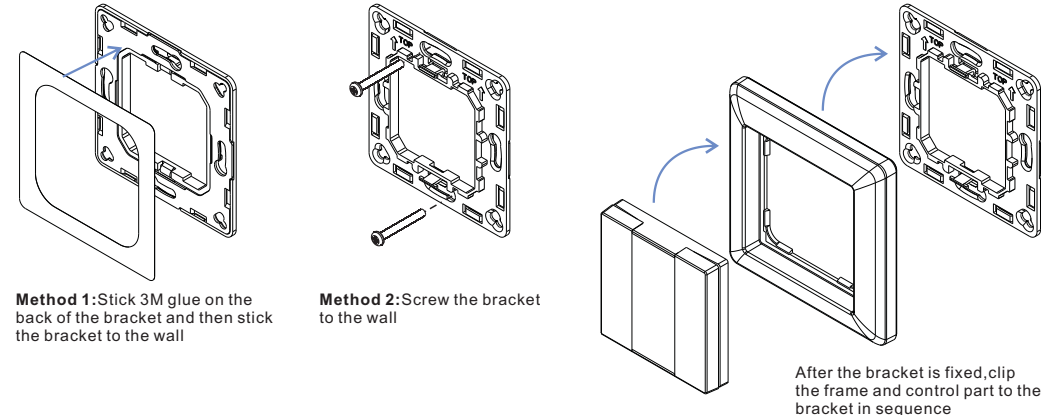

Method 1: Stick 3M glue on the back of the bracket and then stick the bracket to the wall

Method 2: Screw the bracket to the wall

Mounting

The key part of this controller is an universal one, especially rotary standard switch element that can be integrated in numerous frames by different manufactures as below list:

BEKER	S1, B1, B3, B7 glass
GIRA	Standard55, E2, Event, Esprit
JUNG	A500, Aplus
MERTEN	M-smart, M-Arc, M-Plan