



qubino®

Your little magic for the smartest home.

USER MANUAL **EN**

QUBINO MINI DIMMER

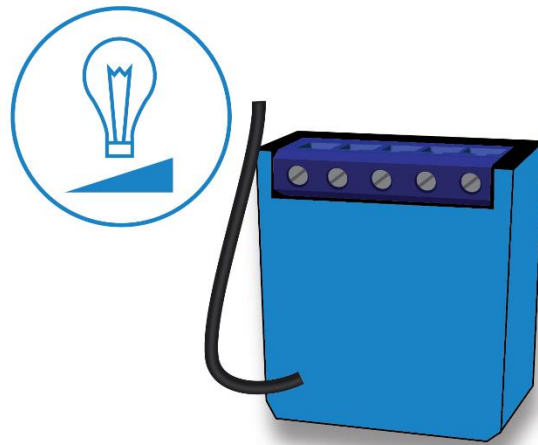

The Qubino Mini Dimmer is the world most compact dimmer. MOSFET-switching light device that also supports control of low-voltage halogen lamps with electronic transformers, dimmable compact fluorescent lights, and dimmable LED bulbs. It can work with or without the neutral line (3 or 2-Wired system).

Table of contents

Table of contents	2
About Qubino.....	4
Safety Information	6
Mini Dimmer - Available Frequencies.....	7
1. Introduction	8
2. Use Cases	10
2.1. Installation examples where Mini Dimmer is installed behind a wall switch in a 2-wired or 3-wired system.....	10
2.2. Additional features of Mini Dimmer which can make your life easier	11
3. Qubino Mini Dimmer Advantages and Highlights	12
3.1. Advantages.....	12
3.2. Highlights	16
4. Package Contents.....	17
5. Technical Terms for Switches	18
6. Compatibility with Z-Wave Gateways (hubs)	19
7. Installation	21
7.1. Installing the device behind a light switch.....	22
8. Device Information and Support	32
9. Electrical Diagram (110 - 240VAC, 24-30VDC).....	33
10. Adding the device to a Z-Wave network (Inclusion).....	34
11. Removing the device from a Z-Wave network (Exclusion).....	35
12. Associations	38
13. Notification Command Class.....	39
14. Configuration Parameters.....	40
15. Technical Specifications	51
16. Z-Wave Command Classes	54
17. Z-Wave Security	56

18. Important Disclaimer 57

19. Warning..... 57

20. Regulations..... 57

[240VAC](#)240VAC

About Qubino

Qubino is a family of innovative Z-Wave devices, many of them the smallest of their kind. Numerous breakthrough innovations, 100% quality control, and responsive customer service make Qubino the number one choice for making your life more comfortable.

Qubino enables you to transform – inexpensively and invisibly – any traditional electric device into a smart, connected one that you can control with your smart phone. Qubino devices are simple to install and use, but also extremely versatile - they offer a wealth of additional features and parameters for you to play with.

We love helping people who enjoy creating new ideas for their home and then using their hard work and skill to turn those ideas into reality. We admire their passion and resourcefulness. We do our best to supply you with products that will enable you to create a unique and special home for yourself. We innovate so that you can be free to make the smartest home possible. With just a touch of magic.

"Simple is smart." We believe it is smart to make complex things simple. But only when this means simple for our customers, not for ourselves. We think a lot so that you won't have to when it comes to installing or using our devices.

For more information visit: www.qubino.com



About Z-Wave:

The Z-Wave protocol is an interoperable, wireless, RF-based communications technology designed specifically for control, monitoring, and status reading applications in residential and light commercial environments. Mature, proven, and broadly deployed (with over 50 million products sold worldwide), Z-Wave is by far the world market leader in wireless control, bringing affordable, reliable, and easy-to-use 'smart' products to millions of people in every aspect of daily life.

Source: www.z-wavealliance.org

Safety Information

For Qubino, safety is first, so we have prepared lots of safety tips and information that can be found throughout this manual.

To ensure your safety, please read this manual carefully before installing the device; follow the instructions exactly. The manufacturer (GOAP d.o.o. Nova Gorica) shall not be legally responsible for any equipment damage or personal injury caused by incorrect installation or operation other than that covered in this manual.



i Please check the Technical Specifications and Electrical Diagram chapters, as well as fuse requirements in the Installation chapter before installing the device.

Mini Dimmer - Available Frequencies

ORDERING CODE (MODEL NUMBER)	POWER SUPPLY FREQUENCY	Z-WAVE FREQUENCY*
ZMNHHD1	50 Hz	868,4 MHz
ZMNHHD2	50 Hz	921,4 MHz
ZMNHHD3	60 Hz	908,4 MHz
ZMNHHD4	50 Hz	869,0 MHz
ZMNHHD5	50 Hz	916,0 MHz
ZMNHHD6	50 Hz	868,4 MHz
ZMNHHD7	50 Hz	919,8 MHz
ZMNHHD8	50 Hz	865,2 MHz
ZMNHHD9	60 Hz	922,5 MHz
ZMNHHDA	60 Hz	920,9 – 921,7 – 923,1 MHz
ZMNHHDB	50 Hz	919,8MHz
ZMNHHDC	60 Hz	868,4 MHz
ZMNHHDD	60 Hz	919,8 MHz
ZMNHHDE	50 Hz	920,9 MHz

*You can check the Z-Wave frequency in your country here:

<https://www.silabs.com/products/wireless/mesh-networking/z-wave/benefits/technology/global-regions>

To find your nearest Qubino dealer visit: <http://qubino.com/where-to-buy/>

1. Introduction

Mini Dimmer is a MOSFET-switching light device that also supports control of low-voltage halogen lamps with electronic transformers, dimmable compact fluorescent lights, and dimmable LED bulbs. It measures power consumption of the connected device. It supports push-button/momentary switches (default) and toggle switches. It can work with or without the neutral line. Qubino Mini Dimmer allows the easiest and quickest installation.

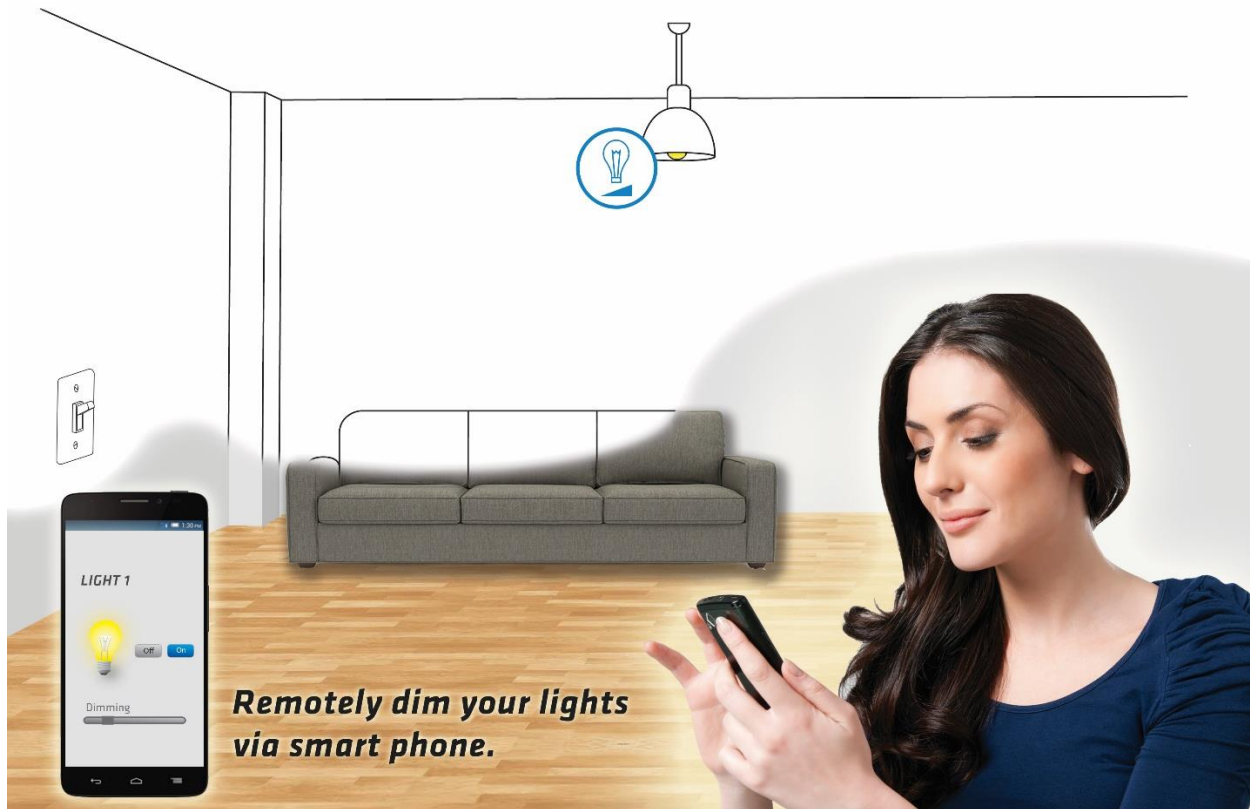

The Qubino Mini Dimmer also acts as a Z-Wave repeater to improve the range and stability of the Z-Wave network.

Mini Dimmer supported functions:

Dim the Lights	Turn on/off	kWh Measurement	W Measurement	2 and 3 wire connection	Associations	Z-Wave Repeater	Auto-inclusion	Automatically turn ON/OFF
✓	✓	✓	✓	✓	✓	✓	✓	✓

Control your house from anywhere



2. Use Cases

The Mini Dimmer can be used in many different scenes, which can help make your life more comfortable. We have prepared a few of them for you, so you can get an idea for your next smart home project. Of course, there are countless of other options for how to use Qubino Mini Dimmer to remotely control devices via your smartphone.

2.1. Installation examples where Mini Dimmer is installed behind a wall switch in a 2-wired or 3-wired system

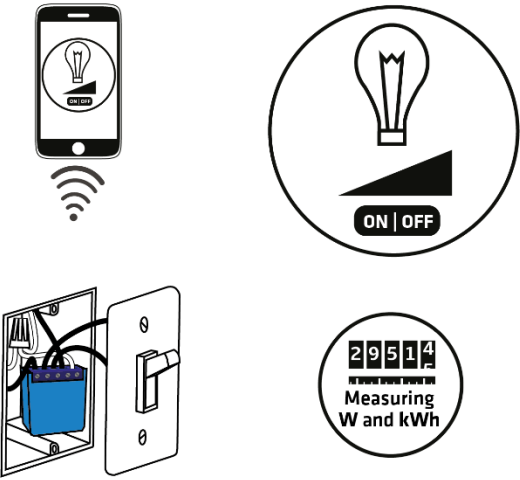
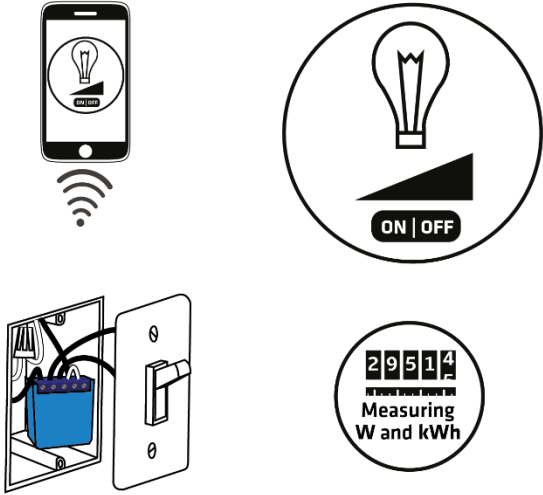
<ul style="list-style-type: none">• Use the Mini Dimmer in a 3-Wired system, to dim your lights or turn them ON/OFF.  <p>The diagram illustrates a 3-wired system installation. It features a smartphone with a lightbulb icon and a dimmer slider, a lightbulb icon with a dimmer slider and 'ON OFF' text, a physical wall switch with the Mini Dimmer module installed behind it, and a circular icon showing a digital display '29514' with the text 'Measuring W and kWh' below it.</p>	<ul style="list-style-type: none">• Use the Mini Dimmer in a 2-Wired system, to dim your lights or turn them ON/OFF.  <p>The diagram illustrates a 2-wired system installation. It features a smartphone with a lightbulb icon and a dimmer slider, a lightbulb icon with a dimmer slider and 'ON OFF' text, a physical wall switch with the Mini Dimmer module installed behind it, and a circular icon showing a digital display '29514' with the text 'Measuring W and kWh' below it.</p>
--	---

2.2. Additional features of Mini Dimmer which can make your life easier

- **Do you often forget to turn off devices when you leave your home, like lights in the basement or attic?**
- The Mini Dimmer can automatically turn lights on or off after a set period (when you're away from home). For example, the light will automatically turn off if it's been on for 8 hours, let's say. This function is independent of other scenes and gateway (hub) commands.

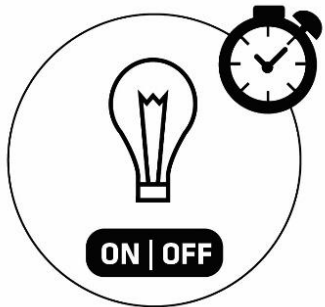

- **Do you know how much energy you consume?**
- The Mini Dimmer monitors and reports energy consumption of connected devices in real time to your smart home app (your gateway (hub) needs to support this feature). Know how much power your lights are using.

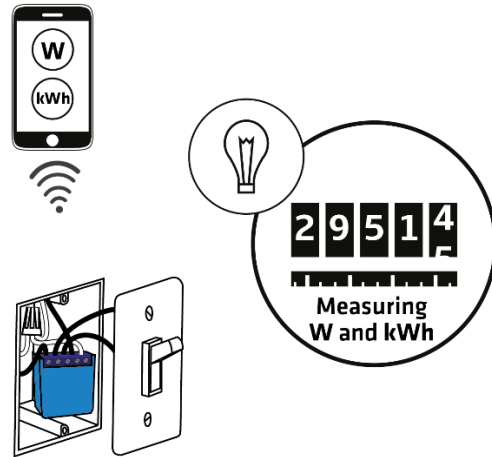

- **Want to control other devices in your Z-Wave network with the Mini Dimmer?**
- Connect the Mini Dimmer with other devices in your network to remotely and automatically trigger another Z-Wave device. And have other Z-Wave devices trigger your Qubino Mini Dimmer.

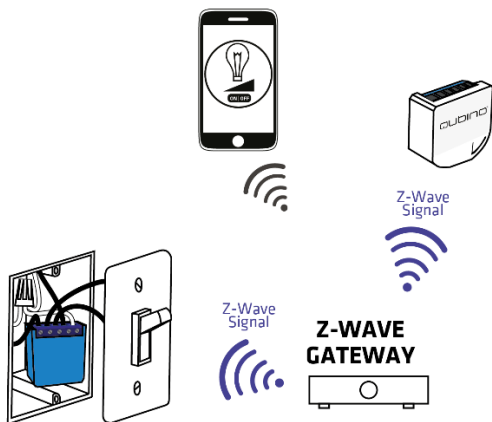

3. Qubino Mini Dimmer Advantages and Highlights

3.1. Advantages

- The Qubino Mini Dimmer **does not need additional protection fuse** beside the installation one (the fuse is part of the device).
- When using the Qubino Mini Dimmer in a 2-Wired system (without the neutral line), **the illuminance of the light will be most effectively utilised**, compared to other dimmers on the market.

Example: dimming a halogen bulb of max illuminance of 100 lux and setting the dimming value to 100%

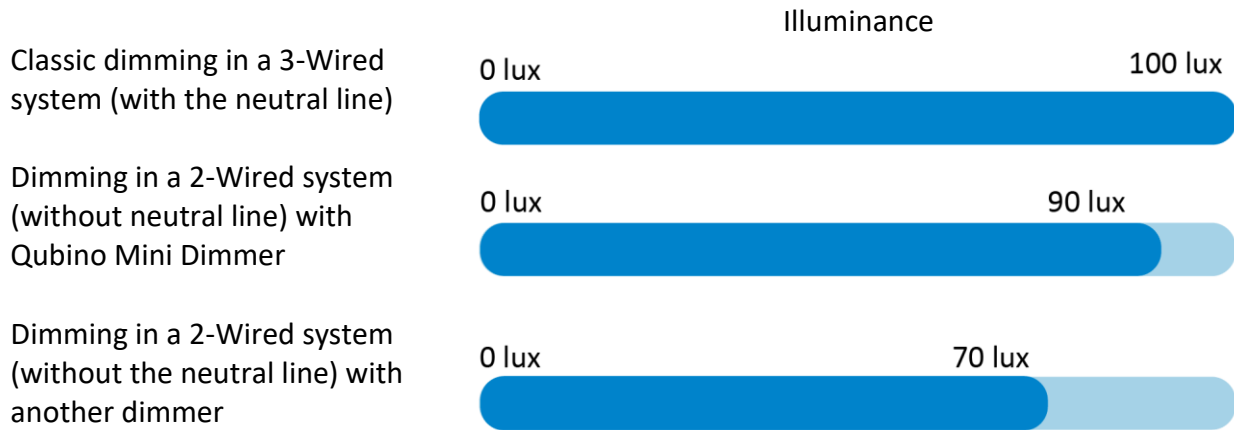

i NOTE: The testing samples of the Mini Dimmer, have the maximum dimming value, in a 2-Wired system, is limited to 55% by the software. Check parameter no. 130.

- The Qubino Mini Dimmer allows the **easiest and quickest installation possible**. Because of its small size, it fits smoothly in even the smallest, most shallow and-most crowded flush mounting boxes, which are stuffed with lots of electrical cables and where **every millimetre counts**. All this is possible because the Qubino Mini Dimmer is **the smallest Z-Wave dimmer in the world**.

This means it can be mounted fast and easy behind a classic switch, which reduces assembly time and installation expenses.

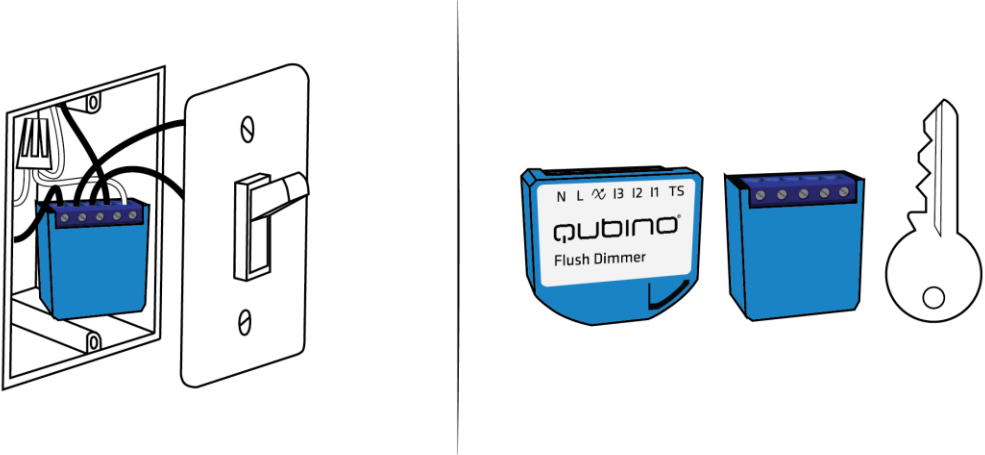

- Mini Dimmer **does not require neutral wire (N)**. It works also in a 2-Wired configuration system, which does not have a neutral line.

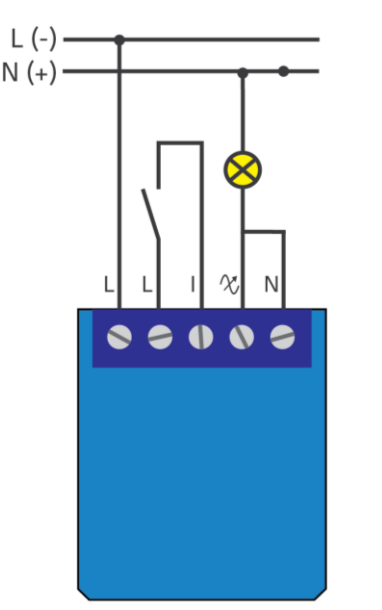

i NOTE: When installing the Mini Dimmer in a 2-Wired system, if the load connected to the output starts flickering, we recommend you use a Bypass

- Qubino Dimmer allows a direct connection of even the smallest bulbs. It's the only Z-Wave dimmer on the market that does not require any minimum load power, which means that the user can connect the bulbs with minimum power loads that are bigger than 0 W (valid only in case of 3-wired connection).



- Qubino guarantees **100% device quality**. Such high quality can be delivered because every Qubino goes through rigorous quality control standards throughout the production process. Every device has a unique serial number and part number, which are assigned to the device only after it goes through a strict testing procedure.



- By scanning the QR code on the back of your Qubino device, the serial and part numbers will be automatically copied on your mobile phone; they also provide **direct access to Qubino’s technical support team**. The serial and part numbers of your device are given automatically every time you open an inquiry with our support team: this instantly shares the relevant device information we need to provide the best technical support possible. For details, please see the Device Information and Support chapter.



- The Qubino Mini Dimmer is **engineered and manufactured in the EU** and contains only the highest quality components.

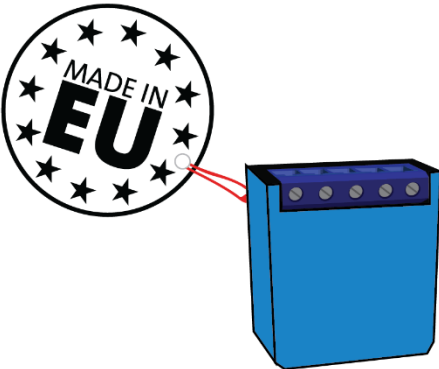

- The Qubino Mini Dimmer is certified by an independent European Institute and has CE, FCC, LVD and EMC certificates to ensure the highest safety standards.

 NOTE: The device is still in the certification stage.

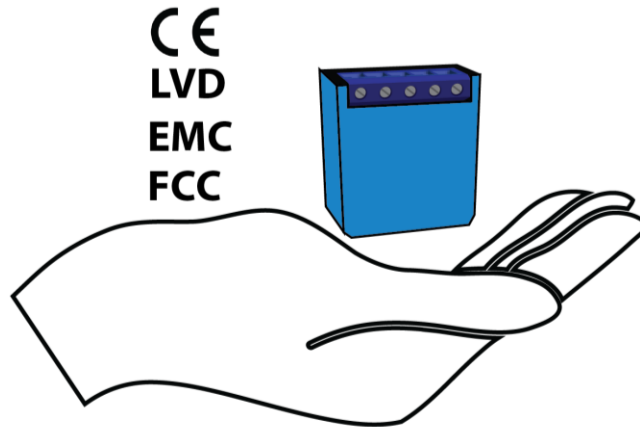

3.2. Highlights





- Remote (via smartphone or PC) and local on/off control of ALL dimmable bulbs
- Does not require a neutral line
- Active power and energy metering in 3 and 2-Wired system
- Works with push-button (momentary switch) or toggle switch
- Capable of measuring the power consumption of the connected device in real time via smartphone, which allows you to save on electricity bills
- Features one of the easiest and quickest installations of devices of this kind; fits in even the smallest flush mounting boxes
- Saves and restores the last status after a power failure
- Supports auto-inclusion mode for quick set up
- Can automatically turn devices on and off after a set period (helpful when you're away from home, for example)
- Supports additional parameters for expert users, which allows advanced configuration*
- Acts as a signal repeater which improves the range and stability of your Z-Wave network
- Can be used to remotely control and trigger other devices in your Z-Wave network
- Is a trailing-edge dimmer, which means that is suitable for different types of the connected load

*Your gateway (hub) needs to support advanced configuration and parameter input if you wish to use this feature

4. Package Contents

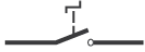
- Mini Dimmer Device
- Installation Manual
- S2 packaging label

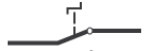
5. Technical Terms for Switches

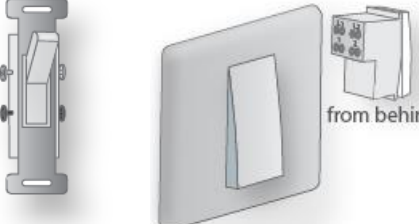
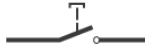
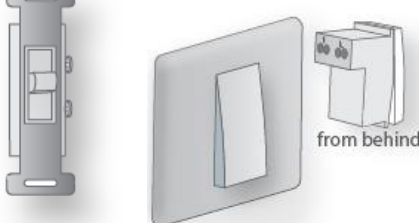
Symbol	Switch example images	Definition	EU	USA	Qubino	Other names
		Single pole, single throw (SPST) - One switch controlling one light / circuit of lights	One-way switch	Two-way switch (regular switch)	Toggle switch	Switch; Bi-stable switch
		Single pole, double throw (SPDT) - Two switches controlling the same light / circuit of lights	Two-way switch	Three-way switch	Two-way switch	
		Used when you have three or more switches controlling the same light	Intermediate switch	Four-way switch	Intermediate switch	Crossover switch; Cross connection
		After being released, it goes back to its original state	Momentary switch		Momentary switch	Monostable switch; Push button

6. Compatibility with Z-Wave Gateways (hubs)

Please check compatibility with your Z-Wave gateway (hub) before you purchase this device.

The compatibility table is in preparation, for any information, please contact us at: <http://qubino.com/support/#email>.

NOTE:

This device must be used in conjunction with a Security Enabled Z-Wave Controller in order to fully utilize all implemented functions.

7. Installation

Before installing the device, please read the following carefully and follow the instructions exactly:

ⓘ Danger of electrocution!

Installation of this device requires a great degree of skill and may be performed only by a licensed and qualified electrician. Please keep in mind that even when the device is turned off, voltage may still be present in the device's terminals.

ⓘ NOTE

Do not connect the device to loads exceeding the recommended values. Connect the device exactly as shown in the provided diagrams. Improper wiring may be dangerous and result in equipment damage.

ⓘ LED Bulbs Compatibility NOTE

We can guarantee dimming compatibility only with halogen bulbs. For dimming LED bulbs please refer to the manufacturer's specifications and make sure to read their recommendations, as dimming behaviour can vary. To ensure acceptable dimming performance we advise independent test, before starting a large-scale installation.

7.1. Installing the device behind a light switch

The installation process, tested and approved by professional electricians, consists of the following simple steps:

Step 1 – Turn OFF the fuse:

- To prevent electrical shock and/or equipment damage, disconnect electrical power at the main fuse or circuit breaker before installation and maintenance.
- Be aware that even if the circuit breaker is off, some voltage may remain in the wires — before proceeding with the installation, be sure no voltage is present in the wiring.
- Take extra precautions to avoid accidentally turning the device on during installation.

STEP 1

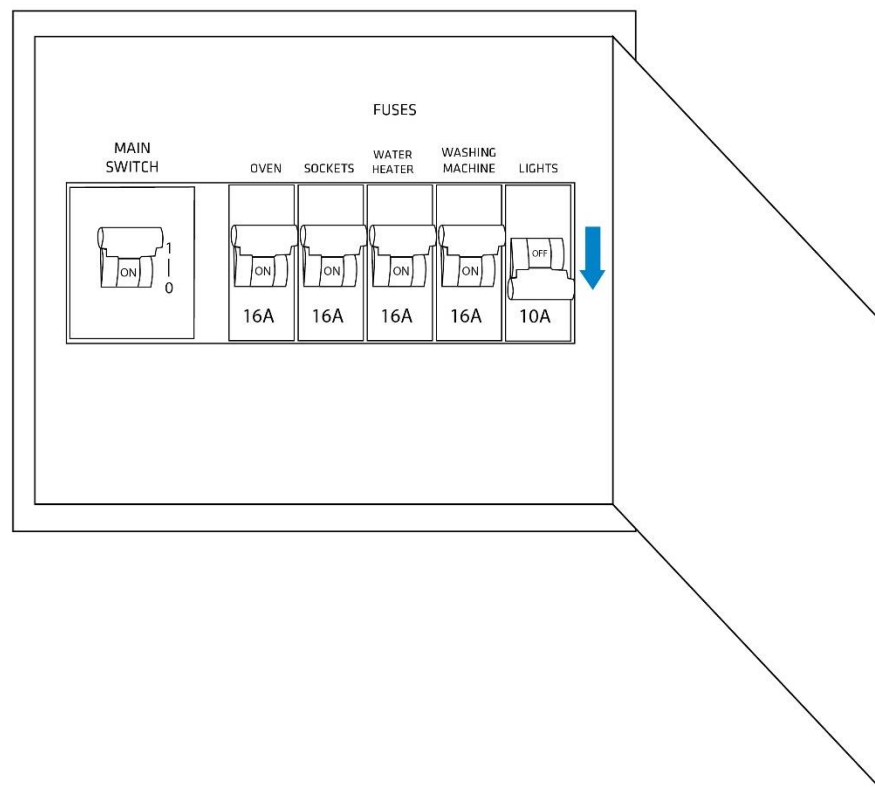

Step 2 – Installing the device:

- Connect the device exactly according to the diagrams shown below

STEP 2

Before Qubino installation:

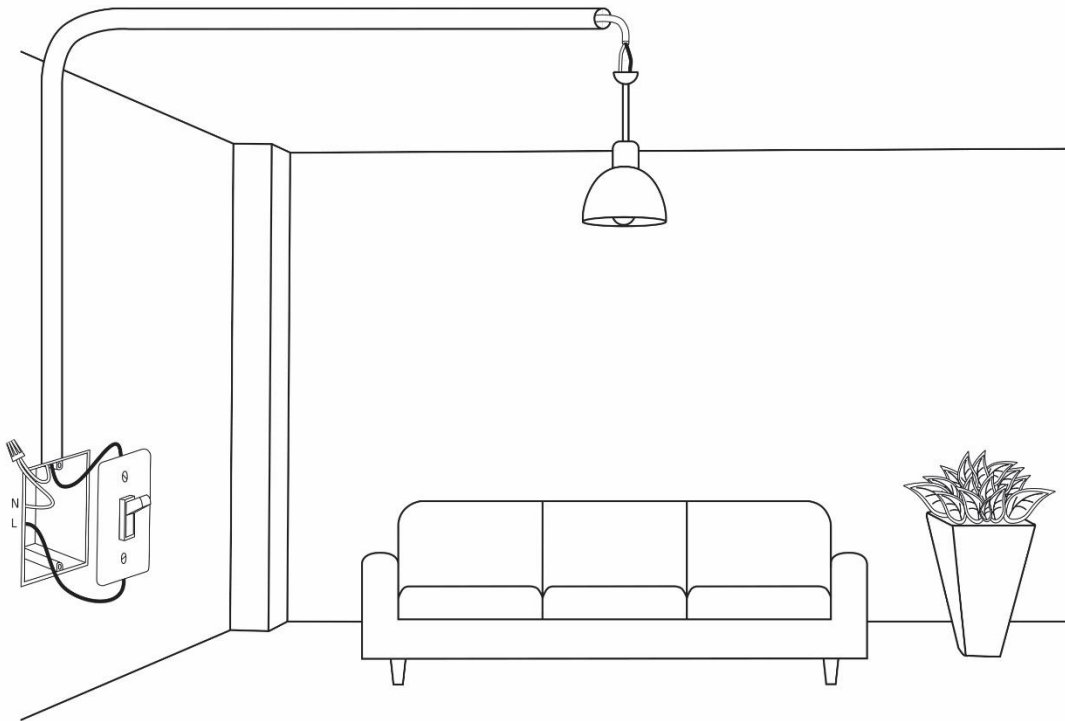

EU example:

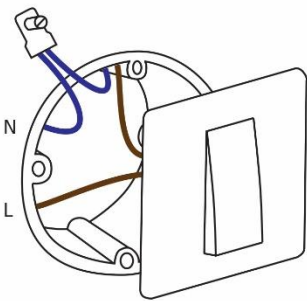

USA example:

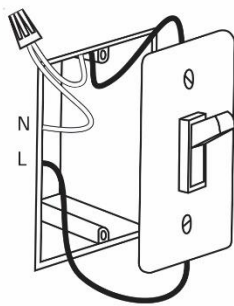

ITA/Brasil example:

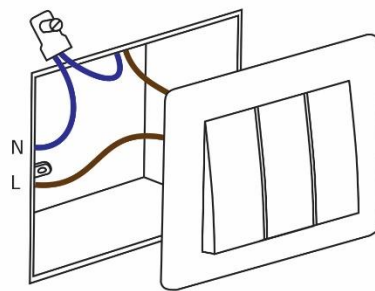

Installation and wire connections are the same in USA, EU and ITA/Brasil.

After Qubino installation:

Connection without a neutral line, 2-Wired system

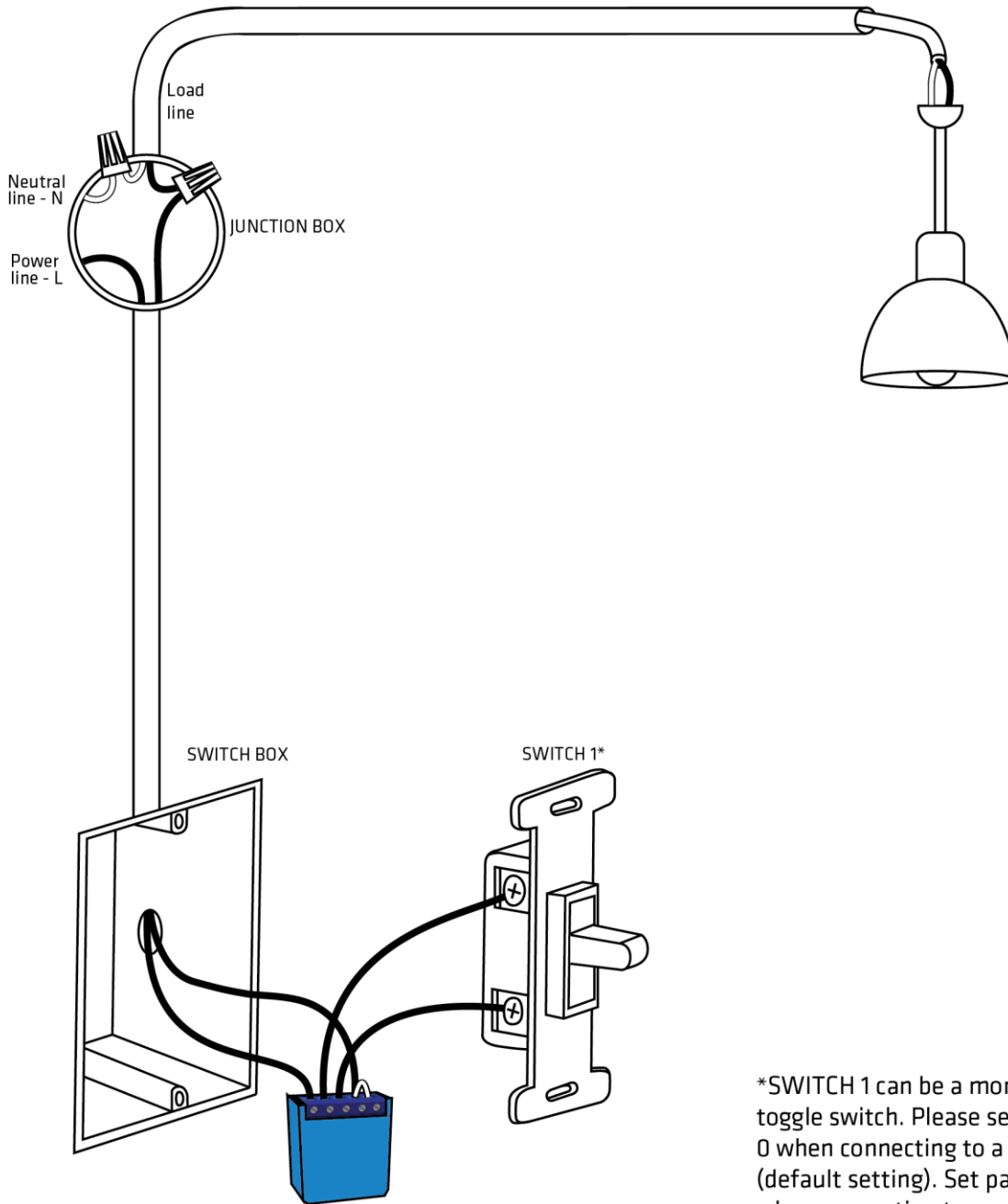

*SWITCH 1 can be a momentary switch or a toggle switch. Please set parameter 1 to value 0 when connecting to a momentary switch (default setting). Set parameter 1 to value 1 when connecting to an on/off toggle switch. Please see the Configuration Parameters chapter for more information about advanced parameter settings

Connection with a neutral line, 3-Wired system

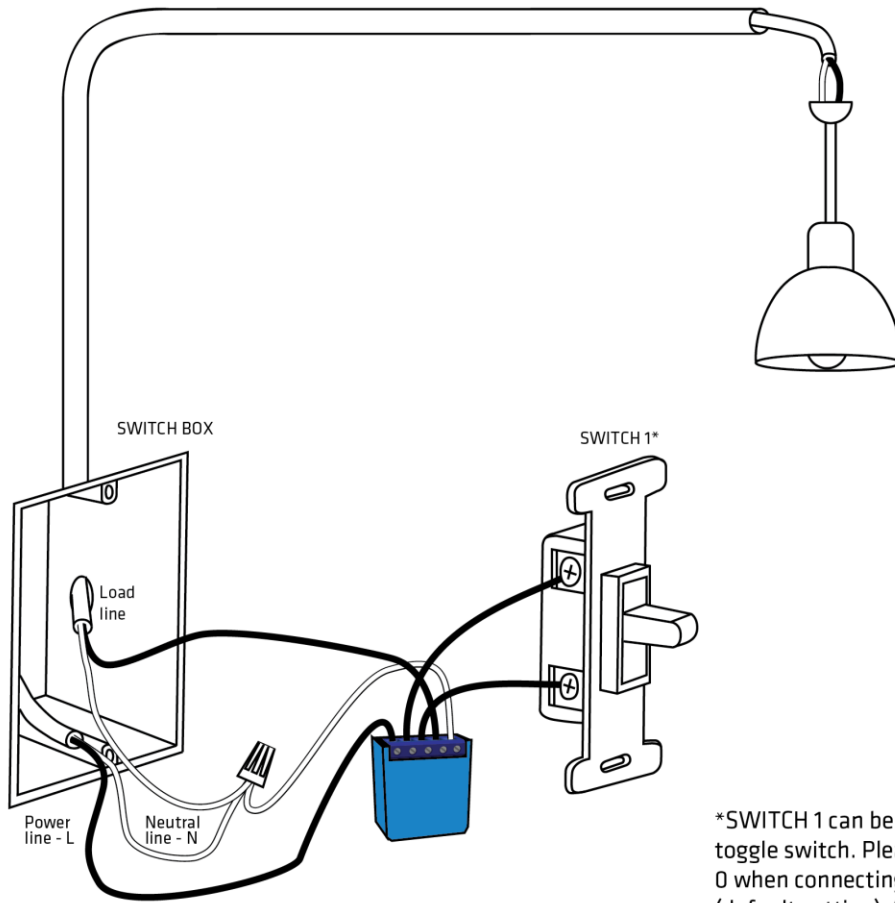

*SWITCH 1 can be a momentary switch or a toggle switch. Please set parameter 1 to value 0 when connecting to a momentary switch (default setting). Set parameter 1 to value 1 when connecting to an on/off toggle switch. Please see the Configuration Parameters chapter for more information about advanced parameter settings

Installation in the switch box:

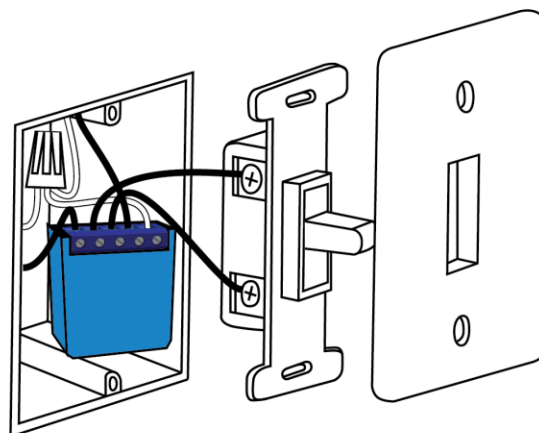

INSTALLATION WITH 2 OR MORE SWITCHES CONTROLLING THE SAME LIGHT:

Before Qubino installation:

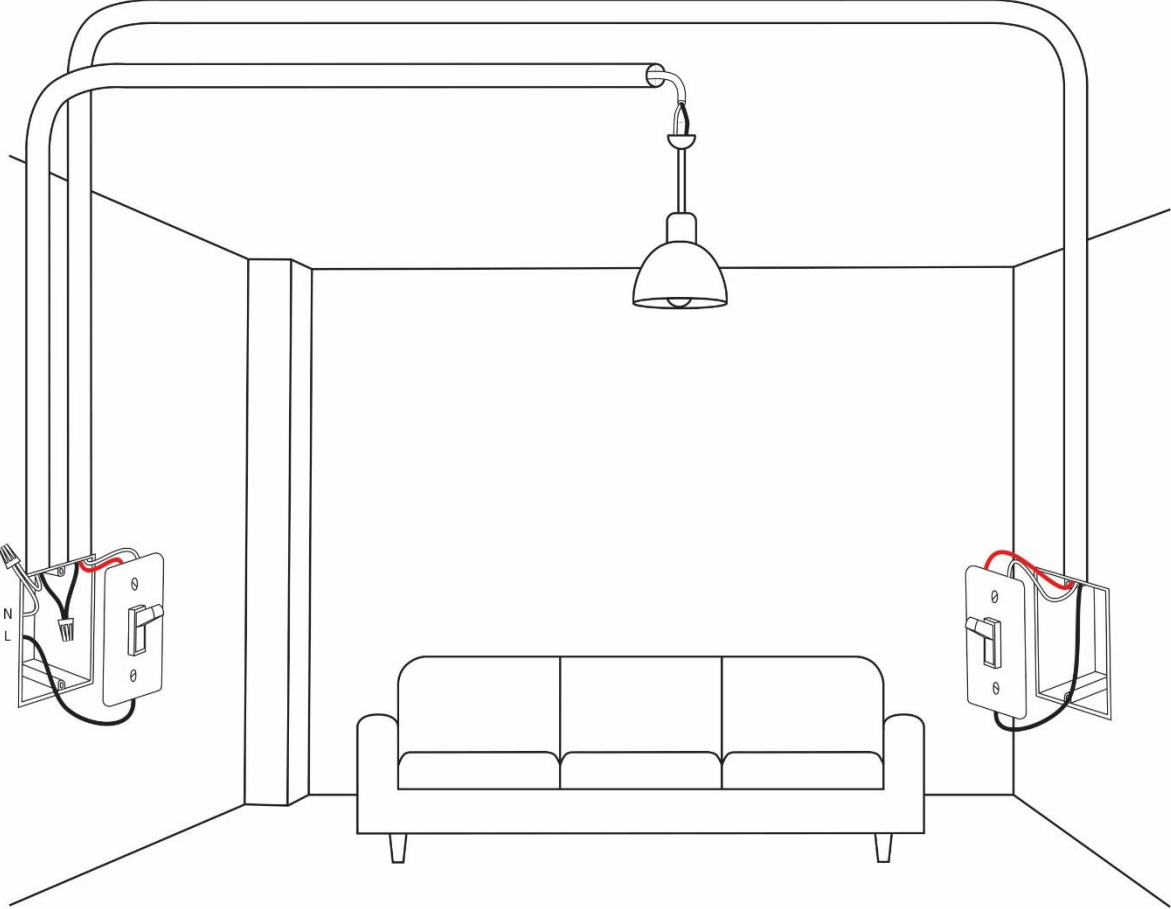

2 WAY SWITCH:

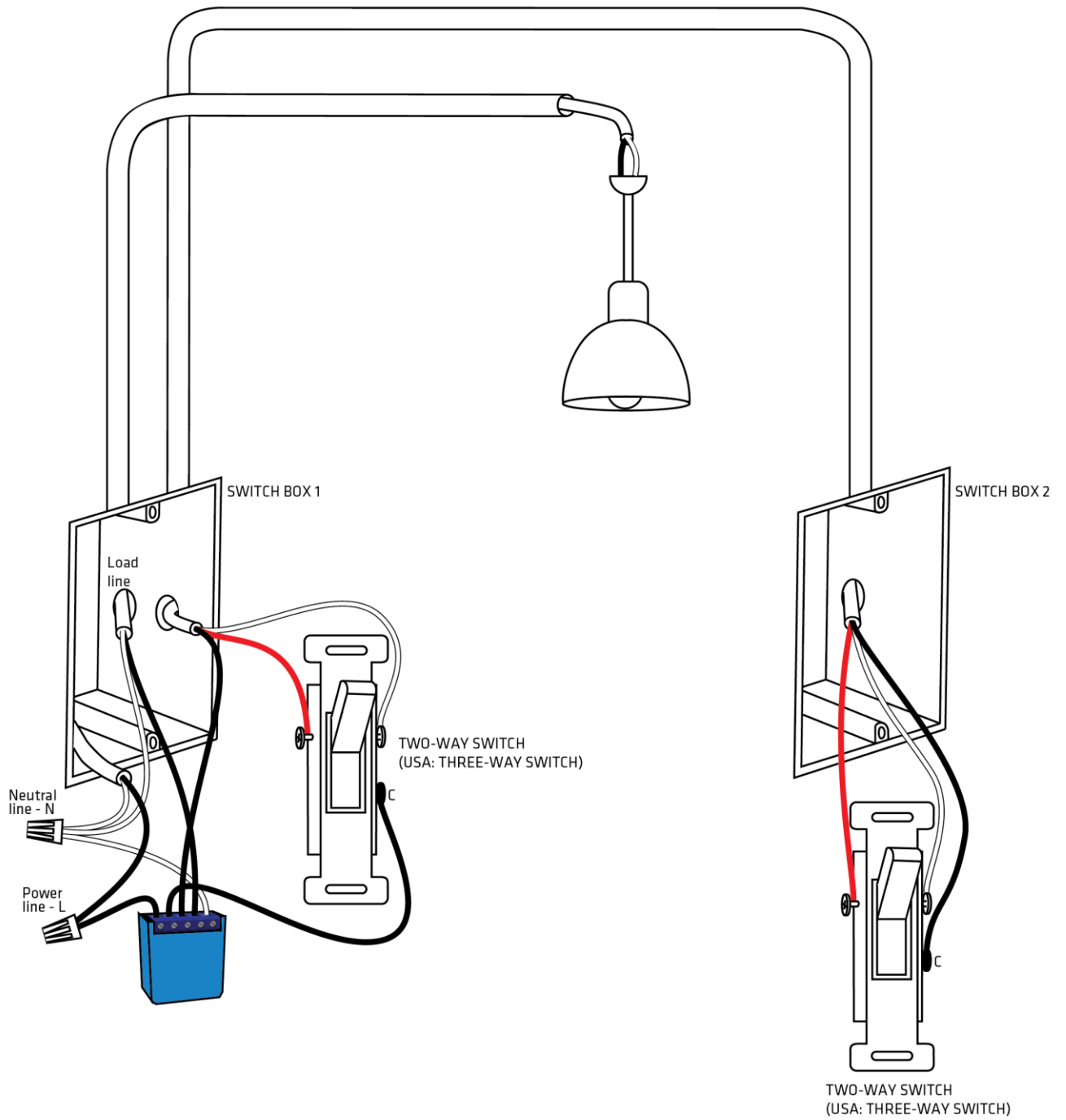

MULTI-WAY SWITCHES:

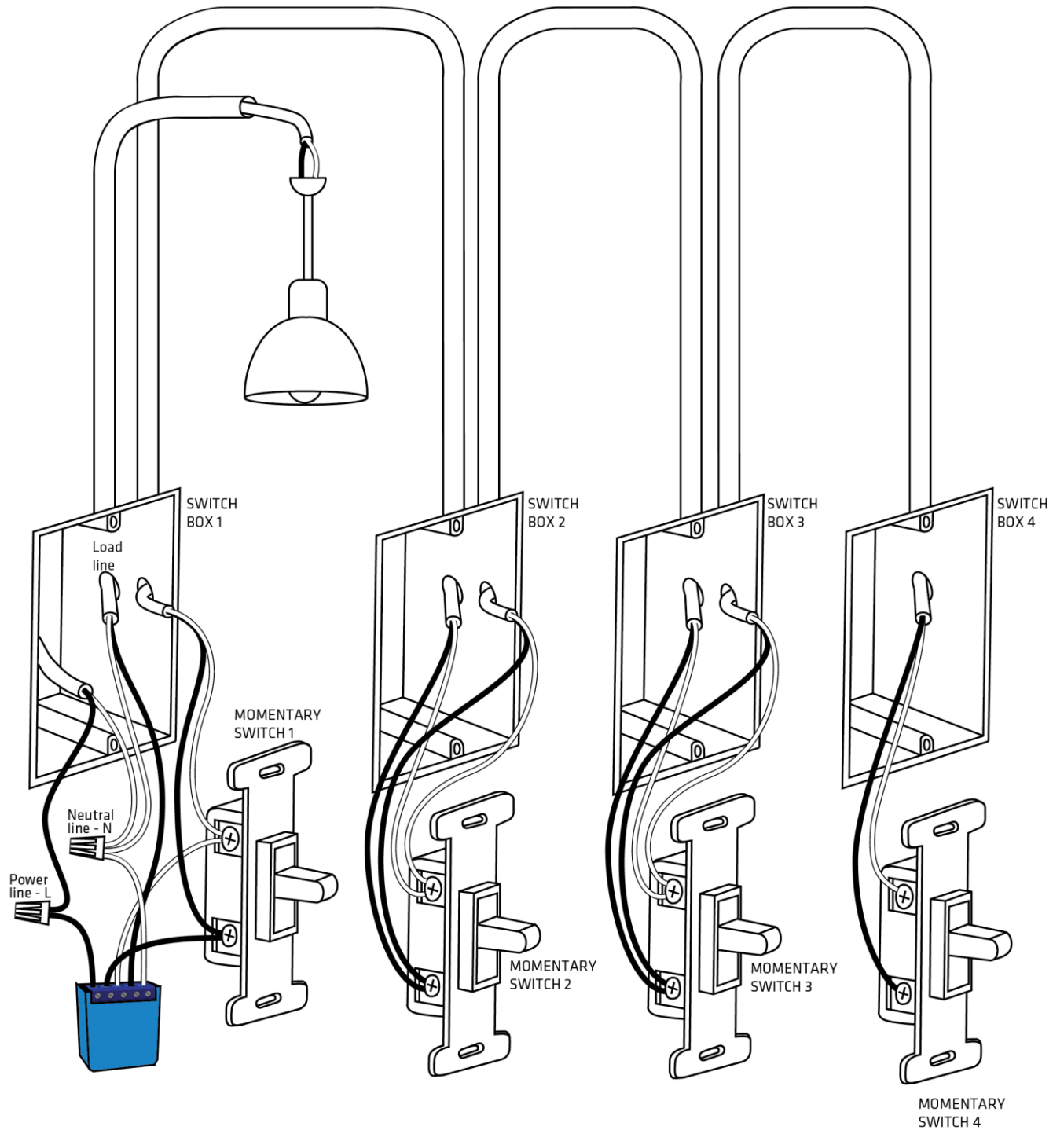

i NOTE

- Place the antenna as far as possible from metal elements as they may cause signal interference.
- Do not shorten the antenna.

The device’s antenna should be as upright as possible. This ensures the device’s operational range is maximized (up to 98 feet (30 m) line of sight).

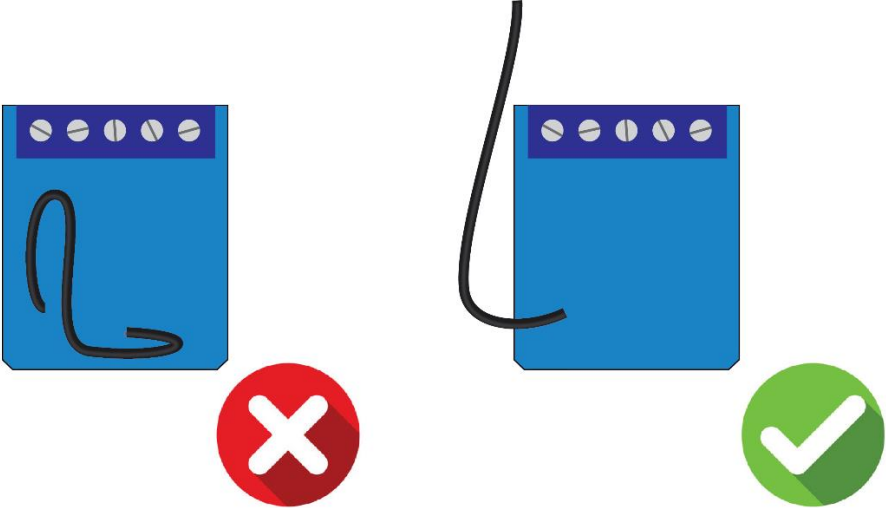

Step 3 – Turn ON the fuse:

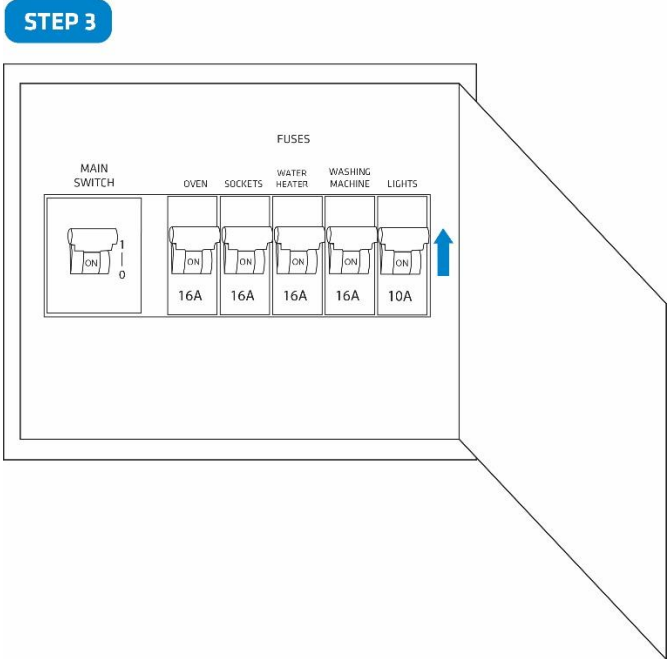

Step 4 – Add the device to your Z-Wave network:

- For more details on how to include the device, please refer to the Z-Wave Inclusion chapter.



Step 5 – The Installation is now complete. It’s time to make your life more comfortable with the help of the Qubino Mini Dimmer

STEP 5

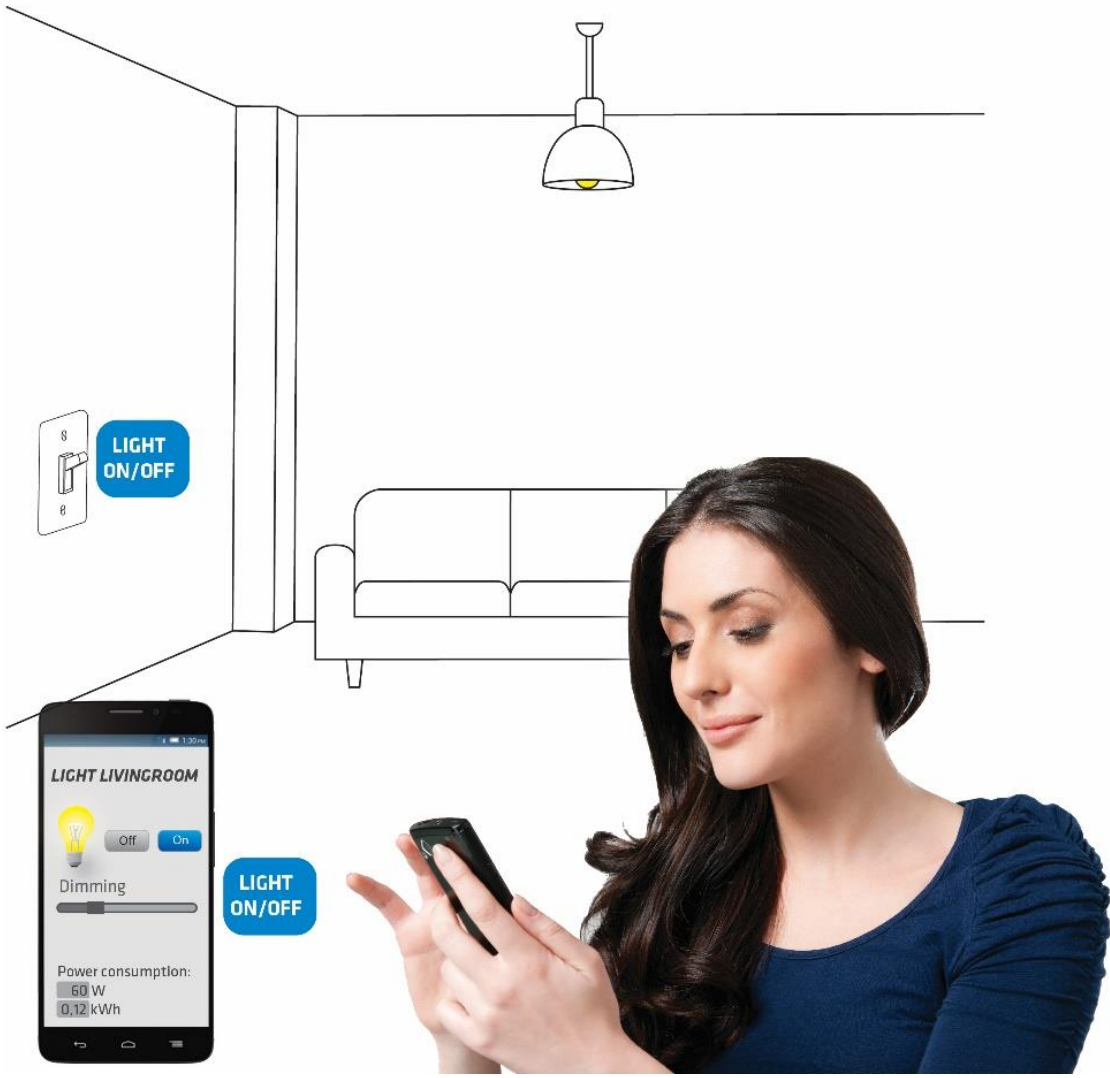

8. Device Information and Support

Did you know that Qubino offers Z-Wave devices with 100% quality control guaranteed throughout the production process? Every single unit is tested and examined before being approved for sale – a truly unique pledge in the industry.

Why is this important?

Every device has a dedicated serial number and part number, which is assigned to the device only after it goes through a strict testing procedure.

By scanning the QR code on the back of your Qubino, its device title, serial number, and part number are automatically copied to your mobile phone. You can also use the code for direct access to the device page for more information. If you still don't find what you're looking for, click on the link to Qubino technical support team. They will be able to automatically read the serial and part number from your device and quickly review the production log file containing the production date as well as any relevant device parameters and information. This process allows our team to immediately identify and address issues, giving you the best support possible.

GET SUPPORT IN 3 SIMPLE STEPS:



Based on customer and business partner feedback, we're proud to boast Qubino's support team as the best and fastest on the market. If you don't find the answers to your questions in this document, please contact our support team by scanning the QR code on your device or through our website: <http://qubino.com/support/#email>. We will try to help you as soon as possible.

9. Electrical Diagram (110 - 240VAC, 24-30VDC)

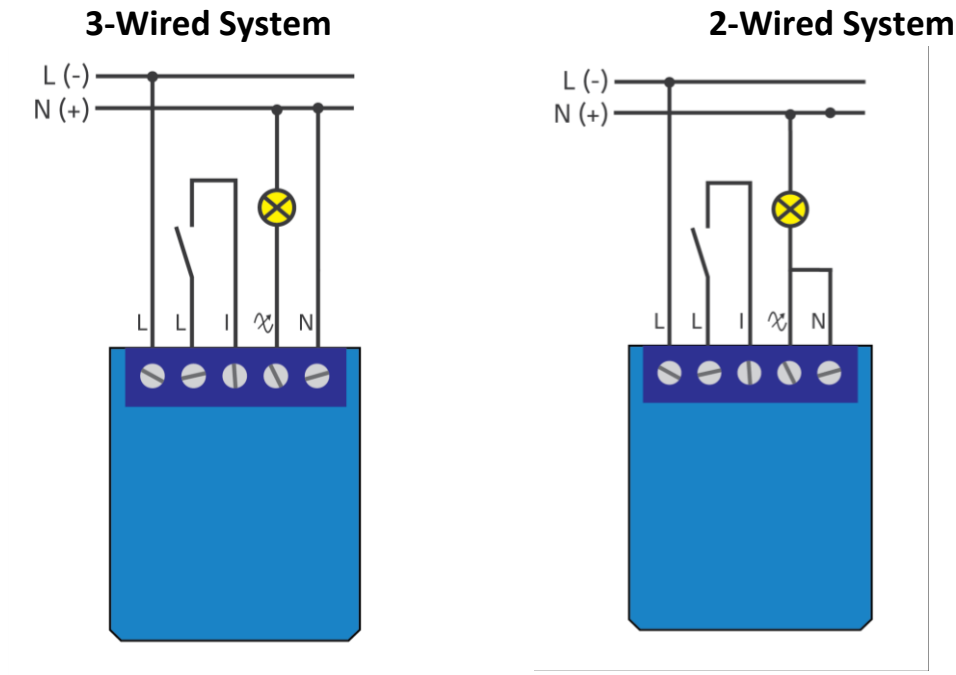

Notes for diagram:

N	Neutral wire (+VDC)
L	Live (line) wire (-VDC)
	Output for electrical device
I	Input for switch/push button *
S	Service button (used to add or remove the device from the Z-Wave network)
LED	<p>When the Mini Dimmer is excluded:</p> <ul style="list-style-type: none"> • green LED is blinking (1 sec ON, 1 sec OFF) • red LED is ON if overload occurs • red LED is blinking (1sec ON, 1 sec OFF) if over temperature occurs • blue LED is blinking (1 sec ON, 1 sec OFF) when calibration is in progress • blue LED is ON if calibration fails <p>When the Mini Dimmer is included:</p> <ul style="list-style-type: none"> • green LED is ON • red LED is ON if overload occurs • red LED is blinking (1sec ON, 1 sec OFF) if over temperature occurs • blue LED is blinking (1 sec ON, 1 sec OFF) when calibration is in progress • blue LED is ON if calibration fails

10. Adding the device to a Z-Wave network (Inclusion)

AUTOMATICALLY ADDING THE DEVICE TO A Z-WAVE NETWORK (AUTO INCLUSION)

1. Enable add/remove mode on your Z-Wave gateway (hub)
2. Automatic selection of secure/unsecure inclusion.
3. The device can be automatically added to a Z-Wave network during the first 2 minutes
4. Connect the device to the power supply
5. Auto-inclusion will be initiated within 5 seconds of connection to the power supply and the device will automatically enrol in your network. (when the device is excluded and connected to the power supply it automatically enters the LEARN MODE state.)

① NOTE: LEARN MODE state allows the device to receive network information from the controller

① NOTE: For S2 inclusion please check chapter – »17. Z-Wave Security«.

① NOTE: Please wait at least 30 seconds between each inclusion and exclusion.

MANUALLY ADDING THE DEVICE TO A Z-WAVE NETWORK (MANUAL INCLUSION)

1. Connect the device to the power supply
2. Enable add/remove mode on your Z-Wave gateway (hub)
3. Toggle the switch connected to the I1 terminal 3 times within 3 seconds (this procedure puts the device in LEARN MODE)

OR

Press and hold the S (Service) button between 2 and 6 seconds if connected to 24-30VDC (this procedure puts the device in LEARN MODE)

4. A new device will appear on your dashboard

① NOTE: LEARN MODE state allows the device to receive network information from the controller

① NOTE: Please wait at least 30 seconds between each inclusion and exclusion.

11. Removing the device from a Z-Wave network (Exclusion)

REMOVAL FROM A ZWAVE NETWORK (Z-WAVE EXCLUSION)

1. Connect the device to the power supply
2. Make sure the device is within direct range of your Z-Wave gateway (hub) or use a hand-held Z-Wave remote to perform exclusion
3. Enable add/remove mode on your Z-Wave gateway (hub)
4. Toggle the switch connected to the I1 terminal 3 times within 3 seconds (this procedure put the device in LEARN MODE)

OR

Press and hold the S (Service) button between 2 and 6 seconds if connected to 24-30VDC (this procedure put the device in LEARN MODE)

5. The device will be removed from your network, but any custom configuration parameters will not be erased

① NOTE: LEARN MODE state allows the device to receive network information from the controller

① NOTE: Please wait at least 30 seconds between each inclusion and exclusion.

FACTORY RESET

1. Connect the device to the power supply
2. Within the first minute the device is connected to the power supply, toggle the switch connected to the I1 terminal 5 times within 3 seconds

OR

Press and hold the S (Service) button for at least 6 seconds if connected to 24-30VDC

① NOTE: By resetting the device, all custom parameters previously set on the device will return to their default values, and the owner ID will be deleted. Use this reset procedure only when the main gateway (hub) is missing or otherwise inoperable.

① NOTE: the reset with switch connected to I1 is possible only in the first minute after the device is connected to the power.

① NOTE: after the reset is successfully done the autocalibration will trigger and the green LED will start blinking.

LED SIGNALIZATION FOR INCLUSION/EXCLUSION

LED (green)

- LED is blinking (1 sec ON, 1 sec OFF) = module is excluded
- LED is ON = module is included

LED (red)

- LED is OFF = normal operation
- LED is ON = overload
- LED is blinking (1 sec ON, 1 sec OFF) = over temperature

LED (blue)

- LED is OFF = normal operation
- LED is blinking (1 sec ON, 1 sec OFF) = calibration in progress
- LED is ON = calibration failed

① NOTE: after each power cycle all 3 LEDs will blink once before resuming normal operation.

MINI DIMMER CALIBRATION

The Mini Dimmer has a calibration function to ensure correct operation in the 2-wire configuration. The calibration determines the maximum and minimum dimming values for the connected load to avoid that the load will take too much voltage from the module for its correct operation.

The calibration will perform automatically once the module is connected to the power for the first time. If the module will not be included in any gateway the calibration will perform again after each power cycle. During the calibration procedure the blue LED will be ON. If the calibration will not perform correctly or any error will occur the blue LED will start blinking. Once the module is included and a power cycle is done the calibration will not start. To force the calibration (in case of load change) or trigger it after each power cycle even if the module is included you need to set the correct value in parameter 71 Calibration Trigger. With parameter 72 you can also check the calibration status in case the module is already mounted and you can't see the LED status. For more information about those parameters please see chapter Configuration parameters on page 40.

① NOTE: when changing the connected load is strongly recommended to force the calibration to ensure correct operation.

OPERATION

The Mini Dimmer can be switch ON/OFF with:

- Pressing the switch connected to I1
- Sending a Basic Set command
- Sending a Switch Binary Set command
- Sending a Switch Multilevel Set command (only if in dimmer mode)
- Sending a Start/Stop Level Change command (only if in dimmer mode)

① NOTE: dimmer or switch mode can be set with parameter 5. Please refer to chapter Configuration parameters for more information.

① NOTE: In Dimmer mode the Basic Set will react as Switch Multilevel Set and In Switch mode the Basic Set command will react like Switch Binary Set.

12. Associations

Use associations for direct communication between the Mini Dimmer and other devices within your Z-Wave network without the need of your primary gateway (hub).

Association Groups:

Root device:

ID	Name	Allowed nodes	Description
1	Lifeline	1	Supports the following command classes: <ul style="list-style-type: none"> • Device Reset Locally: triggered upon request • Meter Report: triggered according to Configuration parameters 40 and 42 • Notification Report: triggered on overload/over temperature • Switch Multilevel Report: triggered upon request or according to Configuration parameters 11 and 12 (note that this command class is active only in dimmer mode) • Switch Binary Report: triggered upon request or according to Configuration parameters 11 and 12 (note that this command class is active only in switch mode)
2	Basic OnOff	16	Supports the following command classes: <ul style="list-style-type: none"> • Basic set: triggered at change of output and reflecting its state
3	StartStop level change	16	Supports the following command classes: <ul style="list-style-type: none"> • Start/Stop Level Change: triggered upon holding and releasing the switch connected to I1
4	Multilevel set	16	Supports the following command classes: <ul style="list-style-type: none"> • Switch Multilevel Set: triggered at change of output and reflecting its state

① NOTE: Association 3 StartStop level change is switch type dependant. The switch must be a bi-stable switch type otherwise the association can not be triggered. To know how to change the switch type connected please refer to chapter Configuration parameters for more information.

① NOTE: When the device is in switch mode (parameter 5 set to 1), association groups 3 and 4 have are not available. Please refer to chapter Configuration parameters for more information.

13. Notification Command Class

The Mini Dimmer supports the following notifications:

- In case of exceeding the power value set in parameter 70 (default 200W) for more than 5 seconds the Mini Dimmer automatically turns off the output and the overload notification is sent.
- In case the parameter 70 is disabled the Mini Dimmer has also a fixed overload safety value of 220W to prevent any damage to the module. Also in this case if the active power is greater than 220W for 5 second or more the output is turned off automatically and a overload notification is sent.

Notification Type	Notification Event
Power Management (0x08)	Over-load detected (0x08)

14. Configuration Parameters

Parameter no. 1 – In-wall Switch Type for Load (⌘) to control I1

With this parameter, you can select between push-button (momentary) and on/off toggle switch types.

Values (size is 1 byte dec):

- default value 0
- 0 - push-button (momentary)
- 1 - on/off toggle switch



Parameter no. 5 – Working mode

With this parameter, you can change the device presentation on the user interface.

Values (size is 1 byte dec):

- default value 0
- 0 - Dimmer mode
- 1 - Switch mode (works only in 3 way wiring-connection with neutral line)

i NOTE: After parameter change, first exclude the device (without setting parameters to default value) then wait at least 30s before reinclusion.

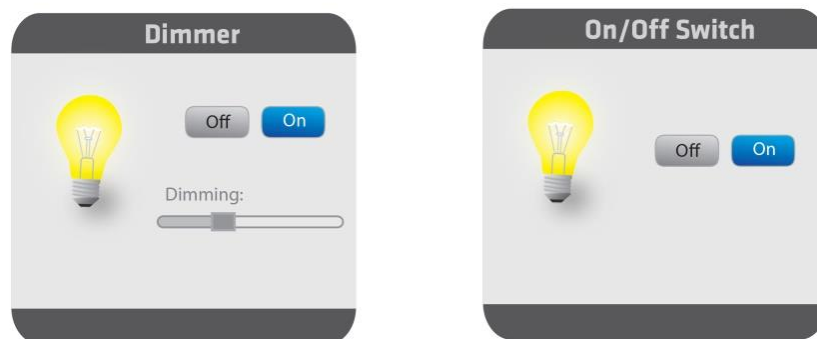

Parameter no. 11 - Turn Load 1 (X) Off Automatically with Timer

If Load (X) is ON, you can schedule it to turn OFF automatically after a period of time defined in this parameter. The timer is reset to zero each time the device receives an ON or OFF command, either remotely (from the gateway (hub) or associated device) or locally from the switch.

Values (size is 2 byte dec):

- default value 0
- 0 - Auto OFF Disabled
- 1 - 32536 = 1 - 32536 seconds - Auto OFF timer enabled for a given amount of seconds

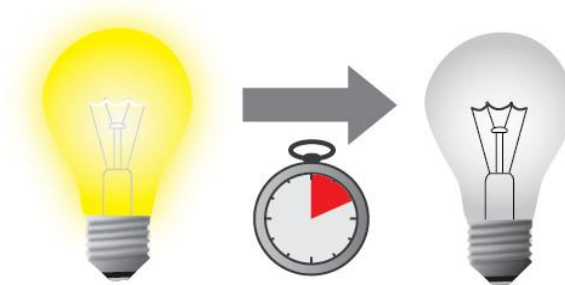
**Parameter no. 12 - Turn Load 1 (X) On Automatically with Timer**

If Load (X) is OFF, you can schedule it to turn ON automatically after a period of time defined in this parameter. The timer is reset to zero each time the device receives an OFF or ON command, either remotely (from the gateway (hub) or associated device) or locally from the switch.

Values (size is 2 byte dec):

- default value 0
- 0 - Auto ON Disabled
- 1 - 32536 = 1 - 32536 seconds - Auto ON timer enabled for a given amount of seconds

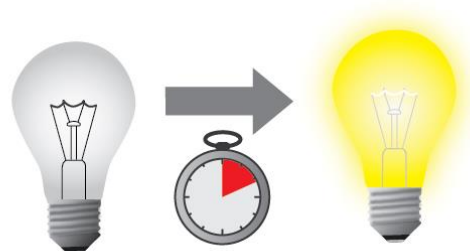

Parameter no. 21 - Enable/Disable the Double click function

If the Double click function is enabled, a fast double click on the push-button will set the dimming level to the maximum dimming value.

Values (size is 1 byte dec):

- default value 0
- 0 - double click disabled
- 1 - double click enabled

**Parameter no. 30 - Restore on/off status for ∞ load after power failure**

This parameter determines if on/off status is saved and restored for the load ∞ after power failure.

Values (size is 1 byte dec):

- default value 0
- 0 - Device saves last on/off status and restores it after a power failure.
- 1 - Device does not save on/off status and does not restore it after a power failure, it remains off.

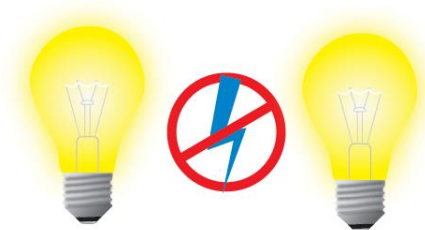

Parameter no. 40 – Watt Power Consumption Reporting Threshold for ∞ Load

Choose by how much the power consumption needs to increase or decrease to be reported. Values correspond to percentages so if 10 is set (by default), the device will report any power consumption changes of 10% or more compared to the last reading.

Values (size is 1 byte dec):

- default value 10
- 0 - Power consumption reporting disabled
- 1 - 100 = 1% - 100% Power consumption reporting enabled. New value is reported only when Wattage in real time changes by more than the percentage value set in this parameter compared to the previous Wattage reading, starting at 1% (the lowest value possible).

i NOTE: The power consumption needs to increase or decrease by at least 2 Watts to be reported, regardless of percentage set in this parameter.

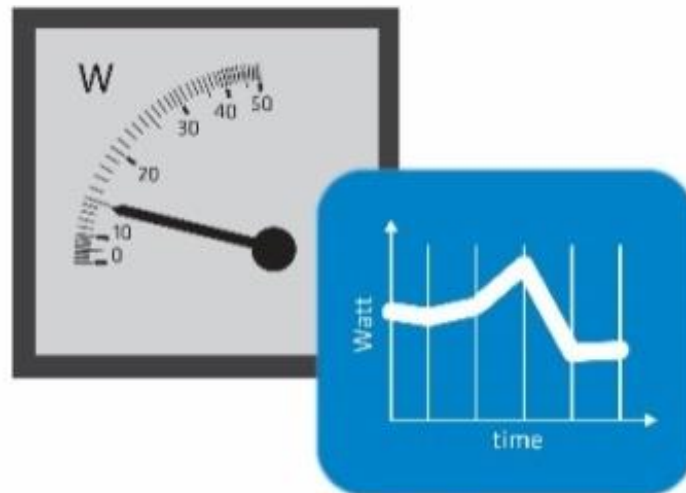

Parameter no. 42 – Watt Power Consumption Reporting Time Threshold for ∞ Load

Set value refers to the time interval with which power consumption in Watts is reported (0 – 32767 seconds). If 300 is entered, energy consumption reports will be sent to the gateway (hub) every 300 seconds (or 5 minutes) if there was a change compared from the last report.

Values (size is 2 byte dec):

- default value 0
- 0 - Power consumption reporting on time interval disabled
- 30 - 32767= 30 - 32767seconds. Power consumption reporting enabled. Report is sent according to time interval (value) set here.

i NOTE: Values from 1 to 29 are ignored by device due to standard recommendation.

i NOTE: The report will be send only if there was a change compared to the last report.

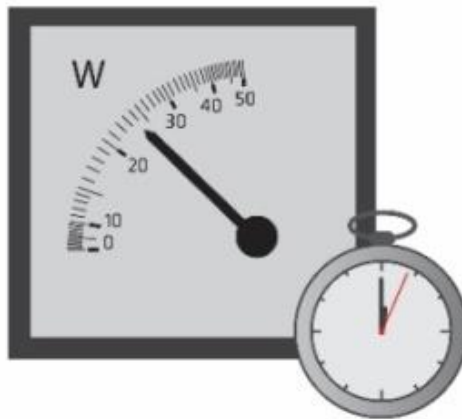

Parameter no. 60 – Minimum dimming value

The value set in this parameter determines the minimum dimming value (the lowest value which can be set on the device, when, for example, dimming lights with wall switch or slider in the GUI (Gateway - hub)) (Data type 1 byte dec)

- default value 0 = 0% (minimum dimming value)
- 0- 98 = 0% - 98%, step is 1%. Minimum dimming value is set by entering a value.

i NOTE: The minimum level may not be higher than the maximum level!



Parameter no. 61 – Maximum dimming value

The value set in this parameter determines the maximum dimming value (the highest value which can be set on the device, when, for example, dimming lights with wall switch or slider in the GUI (Gateway - hub)) Values (size is 1 byte dec):

- default value 99 = 99% (Maximum dimming value)
- 1- 99 = 1% - 99%, step is 1%. Maximum dimming value is set by entering a value.

i NOTE: The maximum level may not be lower than the minimum level!



Parameter no. 65 – Dimming time when key pressed (soft on/off)

Choose the time during which the device will move between the min. and max. dimming values by a short press of the push-button I1.

Values (size is 1 byte dec):

- default value 1 = 1s
- 1 - 127 = 1 seconds- 127 seconds, step is 1 second

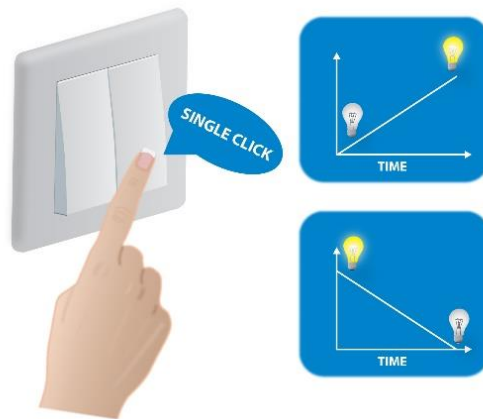
**Parameter no. 66 – Dimming time when key hold**

Choose the time during which the Dimmer will move between the min. and max. dimming values during a continuous press of the push-button I1, by an associated device or through the UI controls (BasicSet, SwitchMultilevelSet).

Values (size is 2 byte dec):

- default value 3 = 3s
- 1-127 = 1 second – 127 seconds
- 128 – 253 = 1 minute – 126 minutes

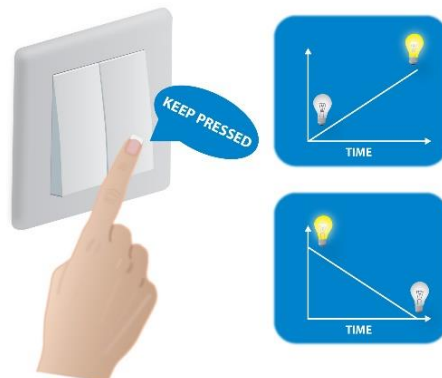

Parameter no. 67 – Ignore start level

Choose whether the device should use (or disregard) the start dimming level value. If the device is configured to use the start level, it should start the dimming process from the currently set dimming level. This parameter is used with association group 3.

Values (size is 1 byte dec):

- default value 0
- 0 – use the start level value
- 1 - ignore the start level value

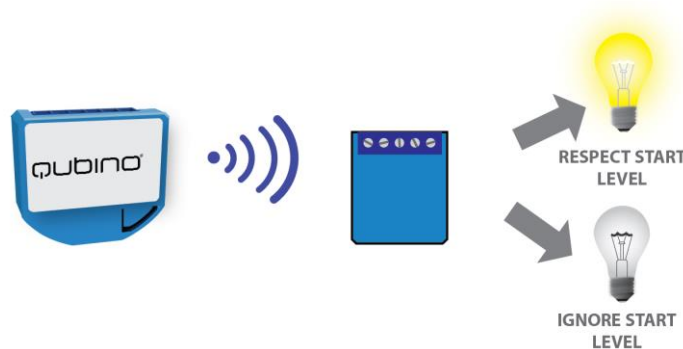

NOTE: Parameter is valid only in Dimmer mode. In Switch mode the parameter has no effect.

Parameter no. 68 – Dimming duration

Choose the time during which the device will transition from the current value to the new target value. This parameter applies to the association group 3.

Values (size is 1 byte dec):

- default value 0 (dimming duration according to parameter 66)
- 1 - 127 (from 1 to 127 seconds)

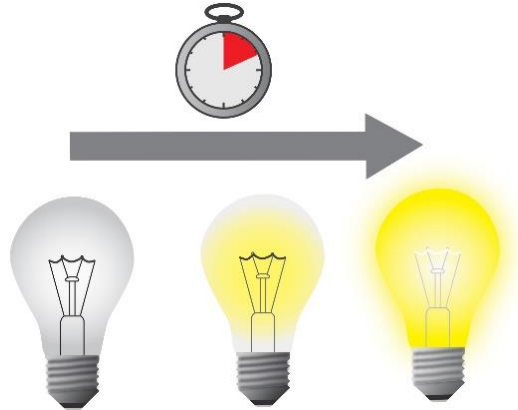

NOTE: Parameter is valid only in Dimmer mode. In Switch mode the parameter has no effect.

Parameter no. 70 - Overload safety switch

The function allows for turning off the controlled device in case of exceeding the defined power for more than 5s. Controlled device can be turned back on by input I1 or sending a control frame.

Values (size is 2 byte dec):

- default value 200
- 1 – 200 = 1 W – 200W
- 0 = function not active

i NOTE: This functionality is not an overload safety protection, please check the technical specifications chapter for more details.

In case of overload the following message will be send towards the controller:

- COMMAND_CLASS_NOTIFICATION_V5
- The Alarm V1 type field set to 0x00
- Notification Type 0x08 and 0x08 (Overload detected)

Parameter no. 71 – Calibration trigger

Choose when will be the calibration procedure triggered.

Values (size is 1 byte dec):

- default value 0 - calibration done after power cycle if module is excluded
- 1 – calibration done after power cycle regardless of inclusion status
- 2 – force calibration. Calibration will start immediately

Parameter no. 72 – Calibration status (read only)

Whit this parameter you can check the calibration status.

Values (size is 1 byte dec):

- default value 2 – calibration failed
- 1 – calibration was successful
- 2 – calibration failed

Parameter no. 73 – Alarm/Notification events

This parameter defines the module behaviour in case it receives any Alarm/Notification events.

Values (size is 1 byte dec):

- default value 0 – function not active
- 1 – turn OFF
- 2 – turn ON
- 3 – start blinking (output turns 1s ON, and 1s OFF)

 NOTE: When value 3 is selected the default time interval of the blinking is 10 minutes. It can be stopped with a button press or sending a control frame. To adjust the time interval please refer to parameter 74 – Alarm/Notification time interval.

Parameter no. 74 – Alarm/Notification time interval (dependant on parameter 73)

This parameter defines the time interval of the blinking state, once the module receives an alarm/notification event. Minimum step increase is 1 minute.

Values (size is 1 byte dec):

- default value 10 = 10 minutes
- 1 – 125 = 1 -125 minutes

 NOTE: This parameter does not have any effect if parameter 73 is not set to value 3.

15. Technical Specifications

Power supply	110 - 240 VAC \pm 10% 50/60Hz*, (24-30VDC**)
Rated load current of AC output	0,85A / 240VAC
Output circuit power of AC/DC output (resistive load)	200W (240VAC)
Power measurement accuracy	+/-2W < 5%, 3W <2%
Operation temperature	-10 ~ +40°C (14 ~ 104°F)
Z-Wave operation range	up to 30 m indoors (98 ft)
Dimensions (WxHxD) (package)	38x33,5x15,5mm (79x52x22mm)
Weight (with package)	28g (34g)
Electricity consumption	0,4W
Mounting	$\varnothing \geq 60$ mm (2,36 in) or 2M, depth ≥ 60 mm (2,36 in)
Switching	MOSFET (Trailing edge)
Z-Wave Repeater	Yes

* 60 Hz is currently not available.

** 24-30VDC connection is used only for adding, removing or performing device reset with S button

Power consumption reporting:

Power consumption in kWh is reported in 0.1kWh intervals.

MEASUREMENTS

W	Power – Active
kWh	Energy – Active power accumulated

Overload safety switch

The user has a option with parameter 70 to set a overload safety switch threshold. If the threshold is set (by default is set to 200W) and the power exceeds it for 5 seconds the Mini Dimmer will turn off, the red LED will turn ON and a “Overload detected” notification will be sent. To restore normal operation the user must press the switch I1 or send a control frame.

Overload protection:

Maximum Power Limit is automatically set by the device’s software which is 220 Watt. If the maximum power is exceeded for more than 5 seconds, the dimmer will turn off until the next power cycle and the red LED will turn ON. If this happens, check if the load matches the device specifications and if connections are according to the diagram. To restore the dimmer to its regular operation, please power cycle the device.

When overload occurs, an “Over-load detected” notification is sent to the gateway (hub).

Maximum Power Limit is not same as Overload safety switch (parameter no. 70).

Watchdog



To protect the Mini Dimmer against getting stuck in an undesired state, the watchdog timer is enabled.

Toggle Switch Mode:

Switch toggles (parameter 1 set to 1) the state of the light bulb between the last dimming value and 0. If the last dimming value is 0 then the light is turned 100% ON when the switch changes its state.

Bulb types which support dimming function:

- Traditional incandescent bulbs
- Halogen bulbs operated by 240 V AC (High Voltage Halogen)
- Low voltage halogen bulbs with electronic or conventional transformers
- Dimmable compact fluorescent bulb (CFL). If the bulb flickers, set the parameter 60 (minimum dimming value) to value 30 or up
- Dimmable LED bulbs

	Conventional incandescent and halogen lights	200W (240VAC) 90W (110VAC)
	LED bulb, compact fluorescent bulb (CFL), low voltage halogen bulbs with electronic transformer	LED: 40W (240VAC) / 20W (110VAC) CFL* LVH Electronic transformer: 70W (240VAC) / 35W (110VAC)
	Low voltage halogen bulbs with conventional transformer	*
	Other type of loads	*

* Please contact Qubino support regarding marked load types:

<http://qubino.com/support/#email>

16. Z-Wave Command Classes

ROOT DEVICE:

GENERIC_TYPE_SWITCH_MULTILEVEL (in Switch mode it changes to
GENERIC_TYPE_SWITCH_BINARY)

SPECIFIC_TYPE_POWER_SWITCH_MULTILEVEL (in Switch mode it changes to
SPECIFIC_TYPE_SWITCH_BINARY)

Supported Z-Wave Command Classes:

COMMAND_CLASS_ZWAVEPLUS_INFO_V2,
COMMAND_CLASS_SUPERVISION_V1,
COMMAND_CLASS_TRANSPORT_SERVICE_V2,
COMMAND_CLASS_SECURITY_V1,
COMMAND_CLASS_SECURITY_2_V1

COMMAND_CLASS_VERSION_V2 [S0]* [S2]*
COMMAND_CLASS_DEVICE_RESET_LOCALLY_V1 [S0]* [S2]*
COMMAND_CLASS_POWERLEVEL_V1 [S0]* [S2]*
COMMAND_CLASS_MANUFACTURER_SPECIFIC_V2 [S0]* [S2]*
COMMAND_CLASS_SWITCH_BINARY_V1 [S0]* [S2]*
COMMAND_CLASS_SWITCH_MULTILEVEL_V3 [S0]* [S2]* (only present in Dimmer mode)
COMMAND_CLASS_METER_V4 [S0]* [S2]*
COMMAND_CLASS_NOTIFICATION_V5 [S0]* [S2]*
COMMAND_CLASS_ASSOCIATION_V2 [S0]* [S2]*
COMMAND_CLASS_ASSOCIATION_GRP_INFO_V2 [S0]* [S2]*
COMMAND_CLASS_CONFIGURATION_V1 [S0]* [S2]*

*[S0] Security Command Class

*[S2] Security S2 Command Class

COMMAND_CLASS_METER

- Default values:
 - Rate Type = 1 (Import)
 - Scale = 0 (kWh)

This Security Enabled Z-Wave Plus Product can be included and operated in any Z-Wave network with other Z-Wave certified devices from any other manufacturers. All constantly powered nodes in the same network will act as repeaters regardless of the vendor in order to increase reliability of the network.

17. Z-Wave Security

Qubino`s Mini Dimmer supports the latest Security 2 feature. Security S2 is handled by the Strong AES 128 Encryption protocol, which means that the S2 makes Z-Wave the most secure IoT (Internet of Things) security platform out there. In order to fully utilize the product and its SECURITY 2 feature, a Security Enabled Z-Wave gateway (hub) must be used.

Authenticated Control

- Out-Of-Band Device Specific Key for inclusion
- May be used by most implementations

Also supports: Security S2 Unauthenticated, Security S0 and Unsecure inclusion

IMPORTANT: When adding the Mini Dimmer to a Z-Wave network with a controller supporting Security 2 (S2), the PIN code of the Z-Wave Device Specific Key (DSK) is required. The unique DSK code is printed on the product label and a copy is inserted in the packaging, which must not be lost. Do not remove the DSK from the product. As a backup measure, use the label in the packaging.

The first five digits of the key are highlighted or underlined to help the user identify the PIN code portion of the DSK text.

The DSK is additionally represented with a QR Code as shown here.



DSK label and QR code (example)

A joining node requesting to join the S2 Access Control Class or the S2 Authenticated Class will obfuscate its Public Key by setting the bytes 1..2 to zeros (0x00) before transferring its key via RF.

A joining node requesting to join only the S2 Unauthenticated Class will send the its full Public Key when transferring the key via RF as the including node has no access to the DSK.

The DSK may be used for out-of-band (OOB) authentication.

- The including gateway (hub) may use QR code scanning device to read the entire DSK off the joining device and match it with the obfuscated public key received via RF from the joining device.

18. Important Disclaimer

Z-Wave wireless communication is not always 100% reliable. This device should not be used in situations in which life and/or valuables are solely dependent on its functioning. If the device is not recognized by your gateway (hub) or shows up incorrectly, you may need to change the device type manually and make sure your gateway (hub) supports multi-channel devices. Contact us for help before returning the device: <http://qubino.com/support/#email>

19. Warning

Do not dispose of electrical appliances as unsorted municipal waste, use separate collection facilities. Contact your local government for information regarding the collection systems available. If electrical appliances are disposed of in landfills or dumps, hazardous substances can leak into the groundwater and get into the food chain, damaging your health and well-being. When replacing old appliances with new ones, the retailer is legally obligated to take back your old appliance for disposal free of charge.

20. Regulations

Legal Notice

This user manual is subject to change and improvement without notice. GOAP d.o.o. Nova Gorica reserves all rights to revise and update all documentation without any obligation to notify any individual or entity.

WEEE

According to the WEEE (Waste electrical and electronic equipment) Directive, do not dispose of this product as household waste or commercial waste. Waste electrical and electronic equipment should be appropriately collected and recycled as required by practices established for your country. For information on recycling of this product, please contact your local authorities, your household waste disposal service or the shop where you purchased the product.



NOTE: User manual is valid for device with SW version S2 (SW version is part of P/N)!

Example:P/N: ZMNHHDxHxS2Px

GOAP d.o.o. Nova Gorica

Ulica Klementa Juga 007, 5250 Solkan, Slovenia

E-mail: info@qubino.com

Tel: +386 5 335 95 00

Web: www.qubino.com

Date: 29.03.2019; V 1.8.1

[DON'T MISS OTHER INVENTIONS FROM QUBINO– CLICK HERE AND CHECK OUT QUBINO'S COMPLETE PORTFOLIO](#)